

## I . SCOPE :

This specification applies to the Pb Free high current type SMD inductors for  
MSI-150705-SERIES

### PRODUCT IDENTIFICATION

MSI-150705- R15 M

① ② ③ ④

- ① Product Code
- ② Dimensions Code
- ③ Inductance Code
- ④ Tolerance Code

## (1) SHAPES AND DIMENSIONS

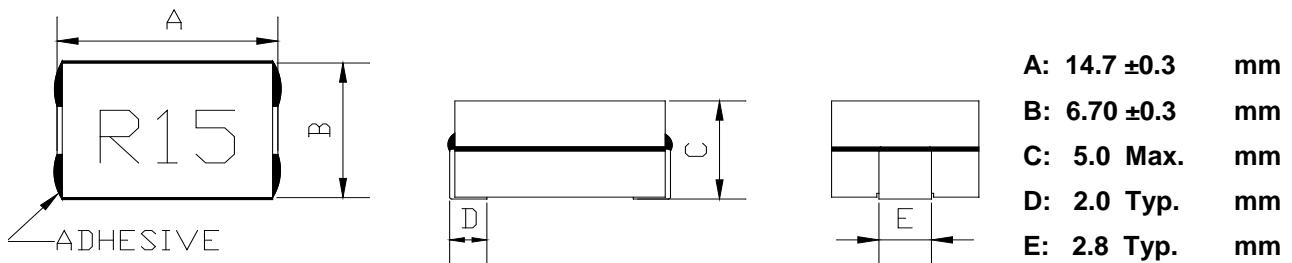

## (2) ELECTRICAL SPECIFICATIONS

### SEE TABLE 1

#### TEST INSTRUMENTS

- L : HP 4284A PRECISION LCR METER (or equivalent)
- RDC : CHROMA MODEL 16502 MILLIOHMMETER (or equivalent)
- IDC1 :WK3255B+3265B (or equivalent)

## (3) CHARACTERISTICS

- (3)-1 Operate temperature range ..... -40°C ~ +125°C  
(Including self temp. rise)
- (3)-2 Storage temperature range ..... -40°C ~ +125°C



## TABLE

MAGLAYERS PT/NO.	Inductance L( $\mu$ H)	Percent Tolerance	Test Frequency	Resistance RDC(m $\Omega$ )	Rated DC Current		Marking
					IDC1(A)	IDC2(A)	
MSI-150705-R12□	0.12	L,M	100kHz/1.0V	0.47 $\pm$ 7%	87	45	R12
MSI-150705-R15□	0.15	L,M	100kHz/1.0V	0.47 $\pm$ 7%	72	45	R15

※ □ specify the inductance tolerance, L( $\pm$ 15%), M( $\pm$ 20%)

※ IDC1 : Based on inductance change ( $\Delta$ L/Lo : drop 20% Typ.)@ ambient temp. 25 $^{\circ}$ C

IDC2 : Based on temperature rise ( $\Delta$ T : 40 $^{\circ}$ C TYP.)

Rated DC Current : The less value which is IDC1 or IDC2 .

## RDC TEST POINT

The nominal DCR is measured from point "a" to point "b" .

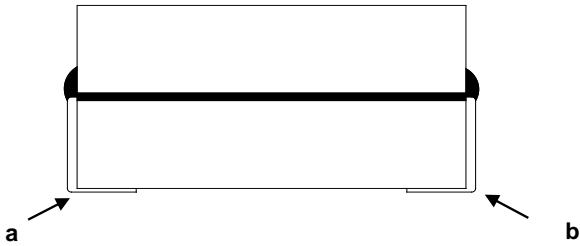

## (4) RELIABILITY TEST METHOD MECHANICAL

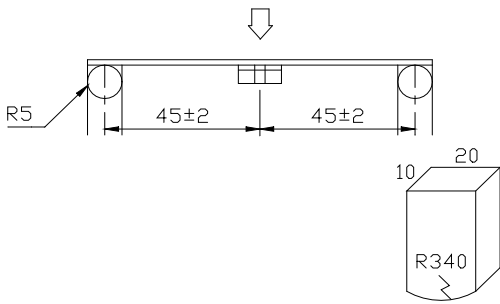
TEST ITEM	SPECIFICATION	TEST DETAILS
Substrate bending	$\Delta L/L_0 \leq \pm 5\%$  There shall be no mechanical damage or electrical damage.	<p>The sample shall be soldered onto the printed circuit board in figure 1 and a load applied until the figure in the arrow direction is made approximately 3mm.(keep time 30 seconds)</p> <p>PCB dimension shall the page 7/9</p> <p>F(Pressurization)</p>  <p>PRESSURE ROD figure-1</p>
Vibration	$\Delta L/L_0 \leq \pm 5\%$  There shall be no mechanical damage.	<p>The sample shall be soldered onto the printed circuit board and when a vibration having an amplitude of 1.52mm and a frequency of from 10 to 55Hz/1 minute repeated should be applied to the 3 directions (X,Y,Z) for 2 hours each. (A total of 6 hours)</p>
Solderability	New solder More than 90%	<p>Flux (rosin, isopropyl alcohol{JIS-K-1522}) shall be coated over the whole of the sample before hard, the sample shall then be preheated for about 2 minutes in a temperature of 130~150°C and after it has been immersed to a depth 0.5mm below for 3±0.2 seconds fully in molten solder M705 with a temperature of 245±5°C.</p> <p>More than 90% of the electrode sections shall be covered with new solder smoothly when the sample is taken out of the solder bath.</p>

## MECHANICAL

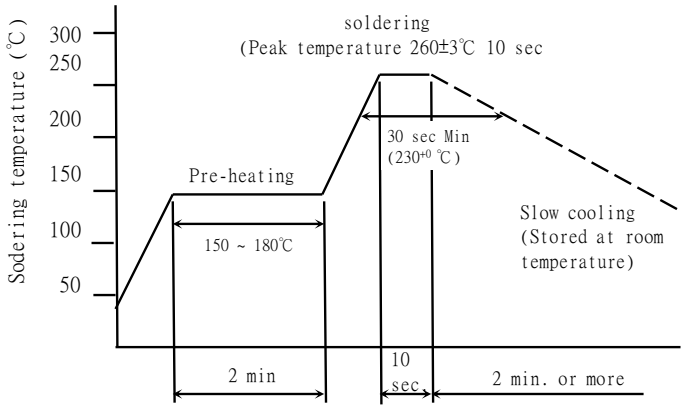
TEST ITEM	SPECIFICATION	
Resistance to Soldering heat (reflow soldering)	There shall be no damage or problems.	<p style="text-align: center;"><b>Temperature profile of reflow soldering</b></p>  <p>The specimen shall be passed through the reflow oven with the condition shown in the above profile for 1 time.</p> <p>The specimen shall be stored at standard atmospheric conditions for 1 hour, after which the measurement shall be made.</p>

## ELECTRICAL

TEST ITEM	SPECIFICATION	TEST DETAILS
Temperature characteristics	$\Delta L/L20^{\circ}\text{C} \leq \pm 10\%$ 0~2000 ppm/°C	The test shall be performed after the sample has stabilized in an ambient temperature of -20 to +85°C, and the value calculated based on the value applicable in a normal temperature and normal humidity shall be $\Delta L/L20^{\circ}\text{C} \leq \pm 10\%$ .



## ENVIROMENT CHARACTERISTICS

TEST ITEM	SPECIFICATION																
High temperature storage	$\Delta L/Lo \leq \pm 5\%$  There shall be no mechanical damage.	The sample shall be left for $96 \pm 4$ hours in an atmosphere with a temperature of $125^\circ\text{C}$ and a normal humidity.  Upon completion of the measurement shall be made after the sample has been left in a normal temperature and normal humidity for 1 hour.															
Low temperature storage	$\Delta L/Lo \leq \pm 5\%$  There shall be no mechanical damage.	The sample shall be left for $96 \pm 4$ hours in an atmosphere with a temperature of $-25 \pm 3^\circ\text{C}$ .  Upon completion of the test, the measurement shall be made after the sample has been left in a normal temperature and normal humidity for 1 hour.															
Change of temperature	$\Delta L/Lo \leq \pm 5\%$  There shall be no other damage of problems	The sample shall be subject to 5 continuous cycles, such as shown in the table 2 below and then it shall be subjected to standard atmospheric conditions for 1 hour, after which measurement shall be made.  <div style="text-align: center;">                         table 2  <table border="1" style="margin: auto;"> <thead> <tr> <th></th> <th style="text-align: center;">Temperature</th> <th style="text-align: center;">Duration</th> </tr> </thead> <tbody> <tr> <td style="text-align: center;">1</td> <td style="text-align: center;"><math>-25 \pm 3^\circ\text{C}</math> (Thermostat No.1)</td> <td style="text-align: center;">30 min.</td> </tr> <tr> <td style="text-align: center;">2</td> <td style="text-align: center;">Standard atmospheric</td> <td style="text-align: center;">No.1→No.2</td> </tr> <tr> <td style="text-align: center;">3</td> <td style="text-align: center;"><math>85 \pm 2^\circ\text{C}</math> (Thermostat No.2)</td> <td style="text-align: center;">30 min.</td> </tr> <tr> <td style="text-align: center;">4</td> <td style="text-align: center;">Standard atmospheric</td> <td style="text-align: center;">No.2→No.1</td> </tr> </tbody> </table> </div>		Temperature	Duration	1	$-25 \pm 3^\circ\text{C}$ (Thermostat No.1)	30 min.	2	Standard atmospheric	No.1→No.2	3	$85 \pm 2^\circ\text{C}$ (Thermostat No.2)	30 min.	4	Standard atmospheric	No.2→No.1
	Temperature	Duration															
1	$-25 \pm 3^\circ\text{C}$ (Thermostat No.1)	30 min.															
2	Standard atmospheric	No.1→No.2															
3	$85 \pm 2^\circ\text{C}$ (Thermostat No.2)	30 min.															
4	Standard atmospheric	No.2→No.1															
Moisture storage	$\Delta L/Lo \leq \pm 5\%$  There shall be no mechanical damage.	The sample shall be left for $96 \pm 4$ hours in a temperature of $40 \pm 2^\circ\text{C}$ and a humidity(RH) of $90 \sim 95\%$ .  Upon completion of the test, the measurement shall be made after the sample has been left in a normal temperature and normal humidity more than 1 hour.															
Test conditions :  The sample shall be reflow soldered onto the printed circuit board in every test.																	

## (5) LAND DIMENSION (Ref.)

PCB: GLASS EPOXY t=1.6mm

### (5)-1 LAND PATTERN DIMENSIONS(mm) (STANDARD PATTERN)



### (5)-2 SUBSTRATE BENDING TEST BENDING TEST BOARD

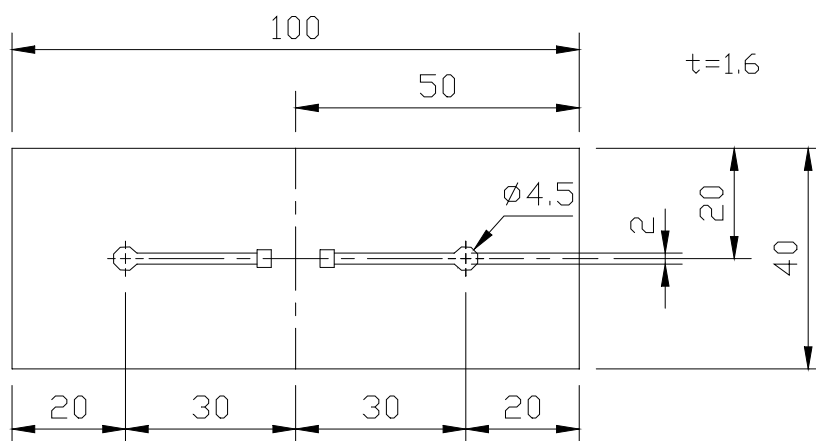

## (6) PACKAGING

### (6)-1 CARRIER TAPE DIMENSIONS (mm)

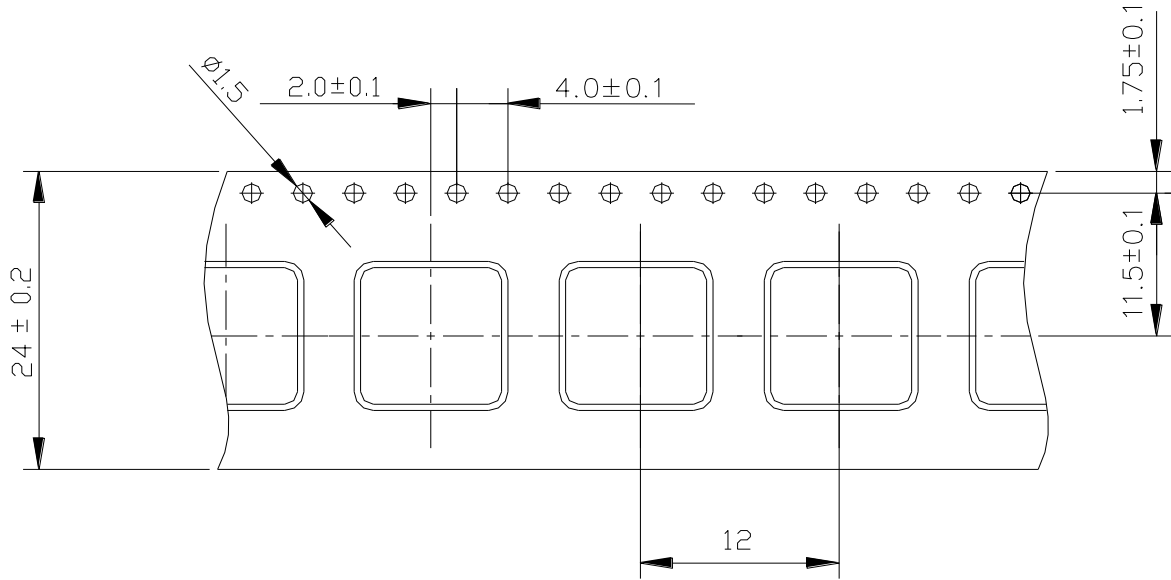

### (6)-2 TAPING DIMENSIONS (mm)

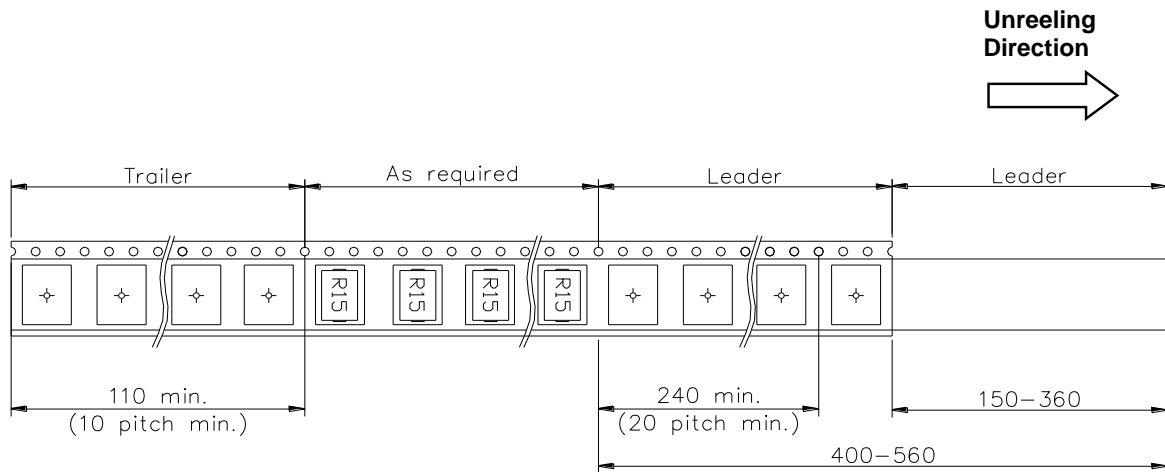

### (6)-3 REEL DIMENSIONS (mm)

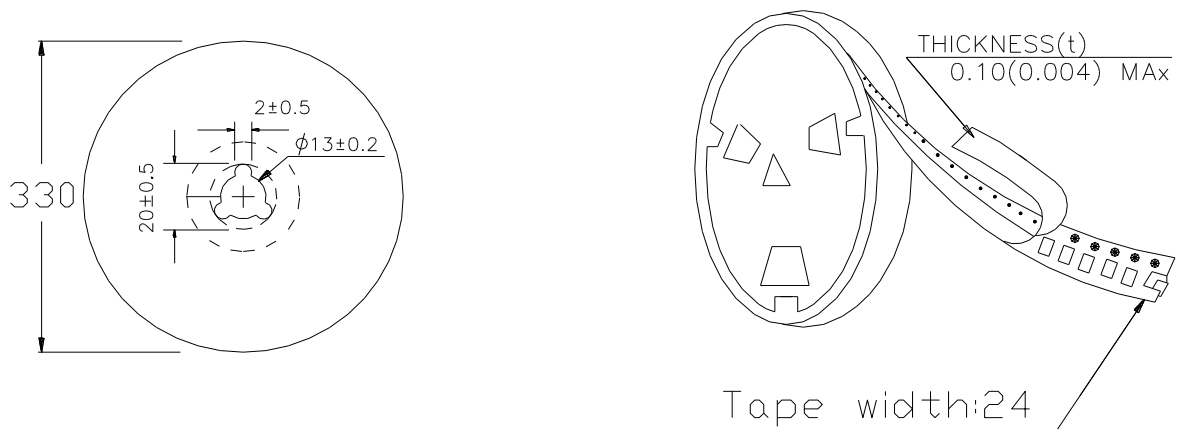

### (6)-4 QUANTITY

800pcs/Reel

The products are packaged so that no damage will be sustained.



## TYPICAL ELECTRICAL CHARACTERISTICS

### INDUCTANCE vs. DC CURRENT@100kHz/1.0V

Ambient Temperature : 25°C

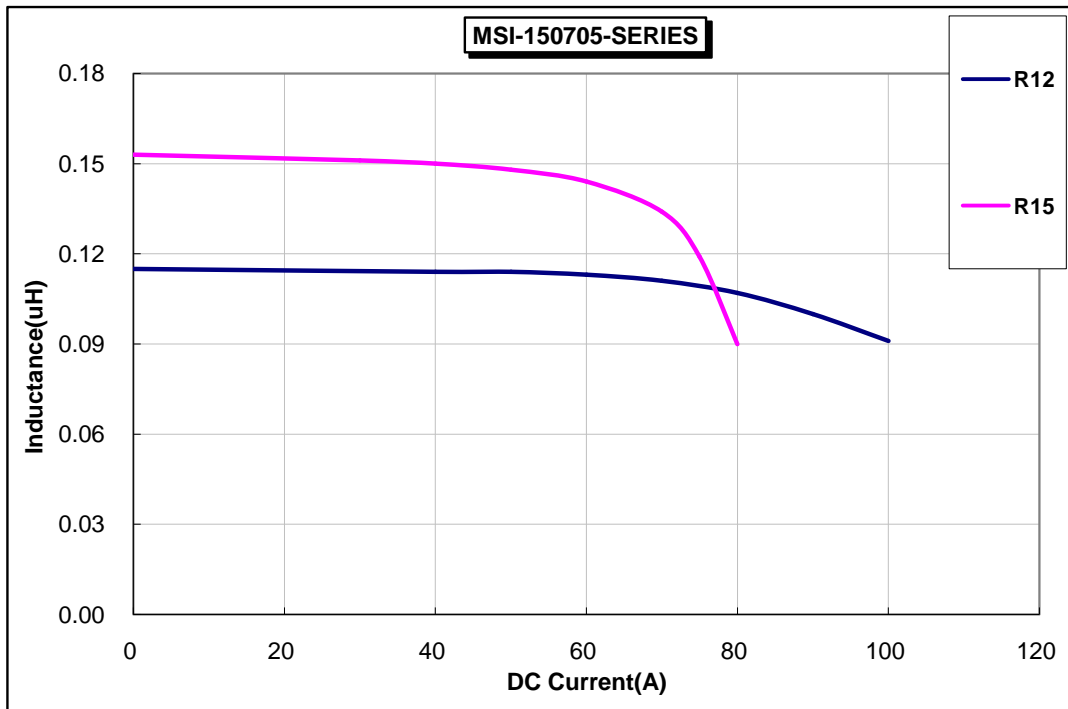

### Temperature Rise vs. DC Current

