



Chip Bead AMLB PY Series

**Automotive
AEC-Q200**

RoHS Compliant
Halogen Free
REACH Compliant



- Noise
Suppression
- Shield
- Multilayer
- Ferrite
- High
Current

Part Numbering

AMLB	160808	0010	Y	PY
Series Name	Dimensions Code (mm)	Impedance (Ω)	Tolerance	Internal Code
	160808 1.6x0.8x0.8	0010 10 0120 120 1000 1000	Y ±25%	

This specification applies to Multilayer Chip ferrite Bead for Automotive Electronics based on AEC-Q200 except for Power train and Safety.



AMLB-160808 Type

■ Dimensions

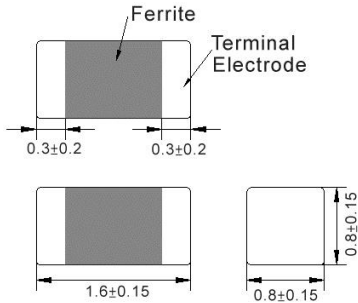

unit:mm

■ Recommended Land Pattern

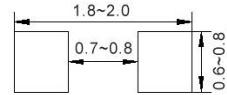

unit:mm

■ Electrical Characteristics

Part No.	Impedance (Ω)	Test Freq.	RDC (Ω)Max.	Rated Current (mA)Max.
AMLB-160808-0010Y-PY	10	100 MHz,200 mV	0.020	4000
AMLB-160808-0030Y-PY	30	100 MHz,200 mV	0.030	3000
AMLB-160808-0060Y-PY	60	100 MHz,200 mV	0.040	3000
AMLB-160808-0080Y-PY	80	100 MHz,200 mV	0.050	2500
AMLB-160808-0120Y-PY	120	100 MHz,200 mV	0.080	2500
AMLB-160808-0180Y-PY	180	100 MHz,200 mV	0.090	2000
AMLB-160808-0220Y-PY	220	100 MHz,200 mV	0.100	2000
AMLB-160808-0300Y-PY	300	100 MHz,200 mV	0.120	1500
AMLB-160808-0470Y-PY	470	100 MHz,200 mV	0.150	1500
AMLB-160808-0600Y-PY	600	100 MHz,200 mV	0.200	1000
AMLB-160808-1000Y-PY	1000	100 MHz,200 mV	0.250	800

Note: When ordering, please specify tolerance code. Tolerance: Y=±25%

1. Operating temperature range - 40°C ~ 125°C
2. Rate Current : Applied the current to coils, the temperature rise shall not be more than 30°C
3. Measure Equipment:
Z: HP4291A
RDC: HP4338B or CHEN HWA 502



AMLB-160808 Type

Characteristics Graph

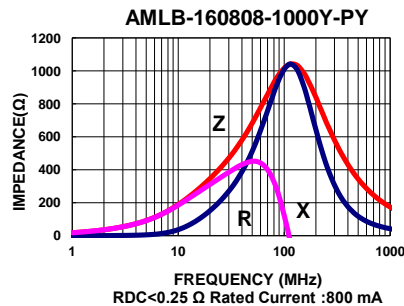
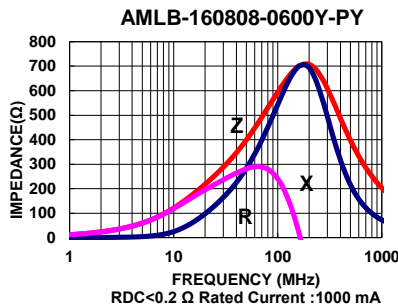
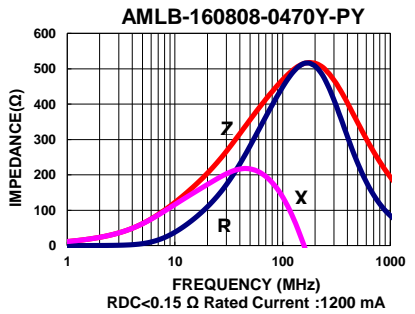
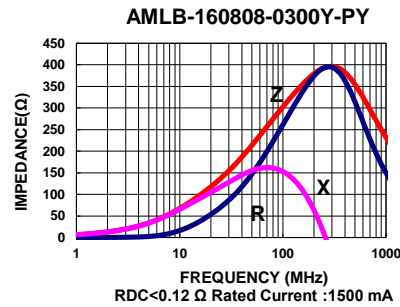
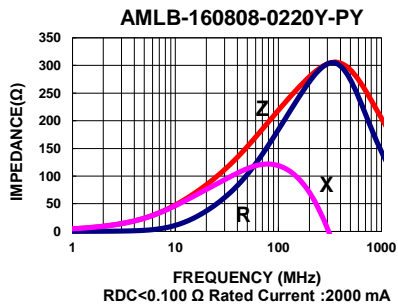
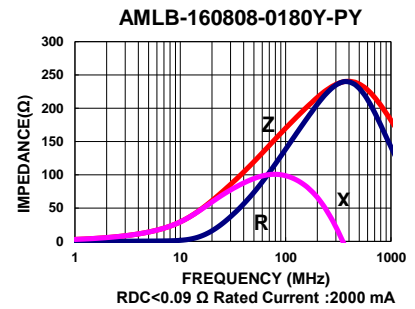
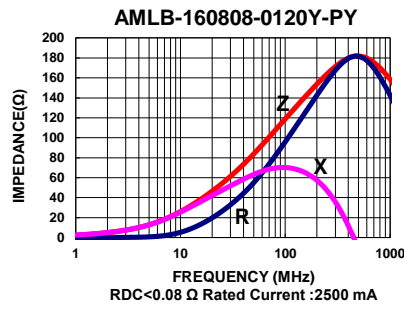
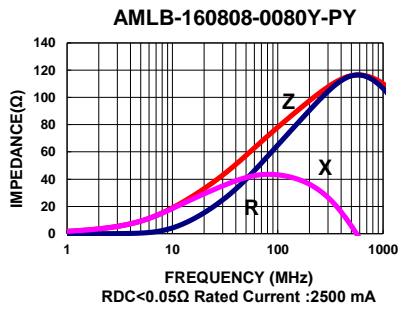
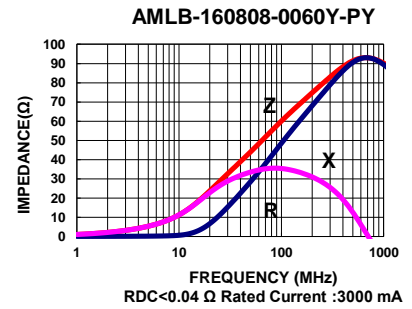
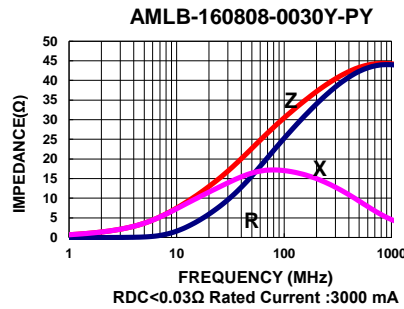
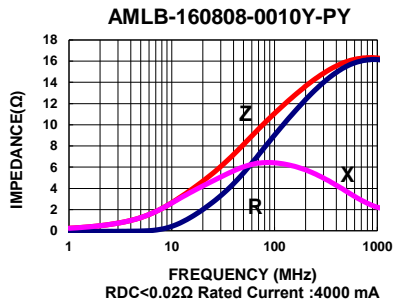



■ Packaging

Tape Dimensions

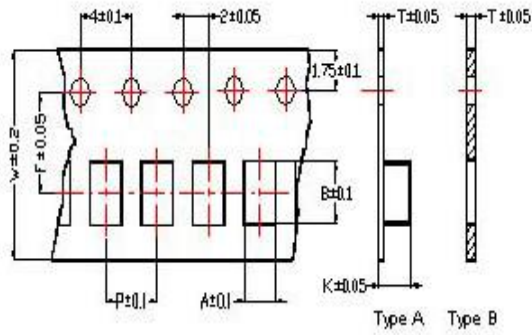

Tape Material

Carrier Tape: Polycarbonate (Tape A)
Carrier Tape: Paper (Tape B)
Cover Tape: Polystyrene

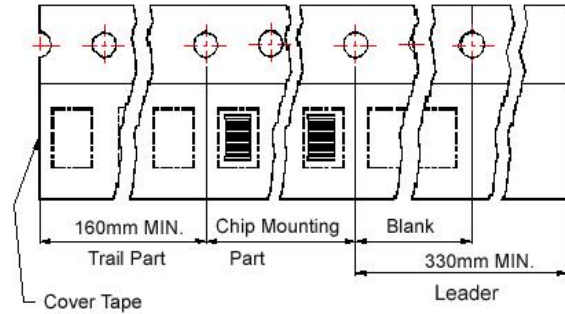

Reel Dimensions

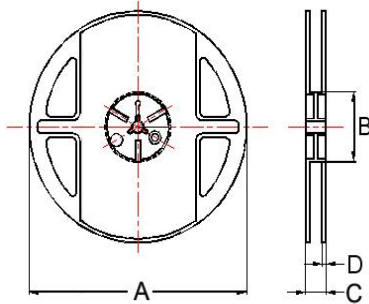

Dimensions in mm

TYPE	Tape Dimensions								Reel Dimensions				Quantity PCS / Reel
	A	B	T	W	P	F	K	Tape	A	B	C	D	
160808	1.05	1.85	0.95	8	4	3.5	-	B	178	60	12	2	4000