

SCOPE :

This specification applies to the Pb Free Signal Common mode filters
for MCI-3216SH-SERIES

PRODUCT IDENTIFICATION

MCI- 3216 SH - 900

① ② ③ ④

- ① Product Code
- ② Dimensions Code
- ③ Signal For AECQ-200
- ④ Impedance Code

(1) SHAPES AND DIMENSIONS

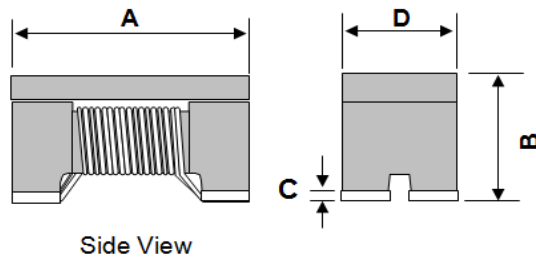

A:	3.2±0.20	mm
B:	1.9±0.20	mm
C:	0.17 Typ.	mm
D:	1.6±0.20	mm
E:	0.6 Typ.	mm
F:	0.6 Typ.	mm

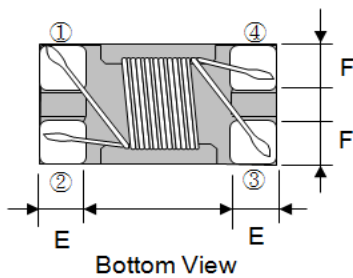

SCHEMATIC

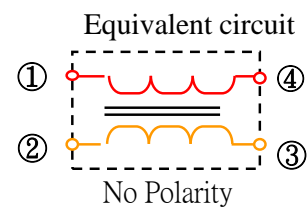

(2) ELECTRICAL SPECIFICATIONS

SEE TABLE 1

TEST INSTRUMENTS

L/Z : HP 4291B IMPEDANCE ANALYZER (or equivalent)

RDC : CHROMA MODEL 16502 MILLIOHMMETER (or equivalent)

I.R : CHROMA MODEL 19073 AC/DC/IR HIPOT TESTER (or equivalent)

(3) CHARACTERISTICS

(3)-1 Operate temperature range $-40^{\circ}\text{C} \sim +155^{\circ}\text{C}$
(Including self temp. rise)



MAG.LAYERS

TABLE 1

MAGLAYERS PT/NO.	Impedance Z(Ω) @ 100MHz/0.5V	RDC (Ω) Max.	Rated Voltage Vdc(V)	Idc Max.(mA)	Withstanding Voltage Vdc(V)	Insulation Resistance (M Ω)Min.
MCI-3216SH-900	90 \pm 25%	0.30	50	370	125	10
MCI-3216SH-121	120 \pm 25%	0.35	50	350	125	10
MCI-3216SH-161	160 \pm 25%	0.40	50	340	125	10
MCI-3216SH-261	260 \pm 25%	0.50	50	310	125	10
MCI-3216SH-601	600 \pm 25%	0.80	50	260	125	10
MCI-3216SH-102	1000 \pm 25%	1.00	50	230	125	10
MCI-3216SH-222	2200 \pm 25%	1.20	50	200	125	10

※ IDC : Based on temperature rise (ΔT : 30°C Typ.)

TEST EQUIPMENT

1. Impedance / Inductance

Measured by using HP 4291B RF Impedance Analyzer.

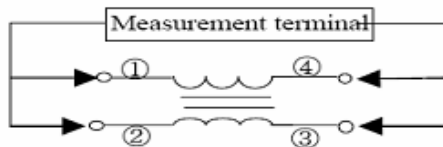

2. DC Resistance

Measured by using Chroma 16502 mill ohm meter

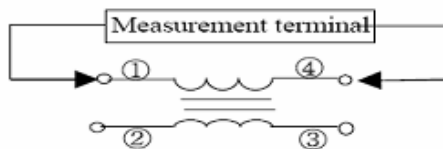

3. Insulation Resistance

Measured by using Chroma 19073

Measurement voltage: 80v, Measurement time: 60 sec.

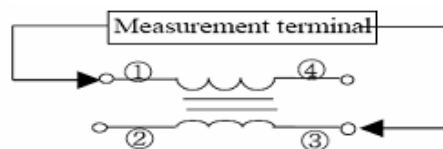

(4) RELIABILITY TEST METHOD

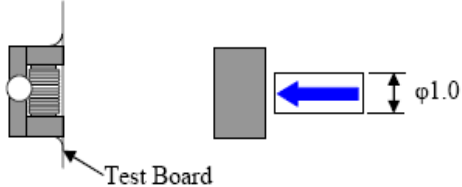
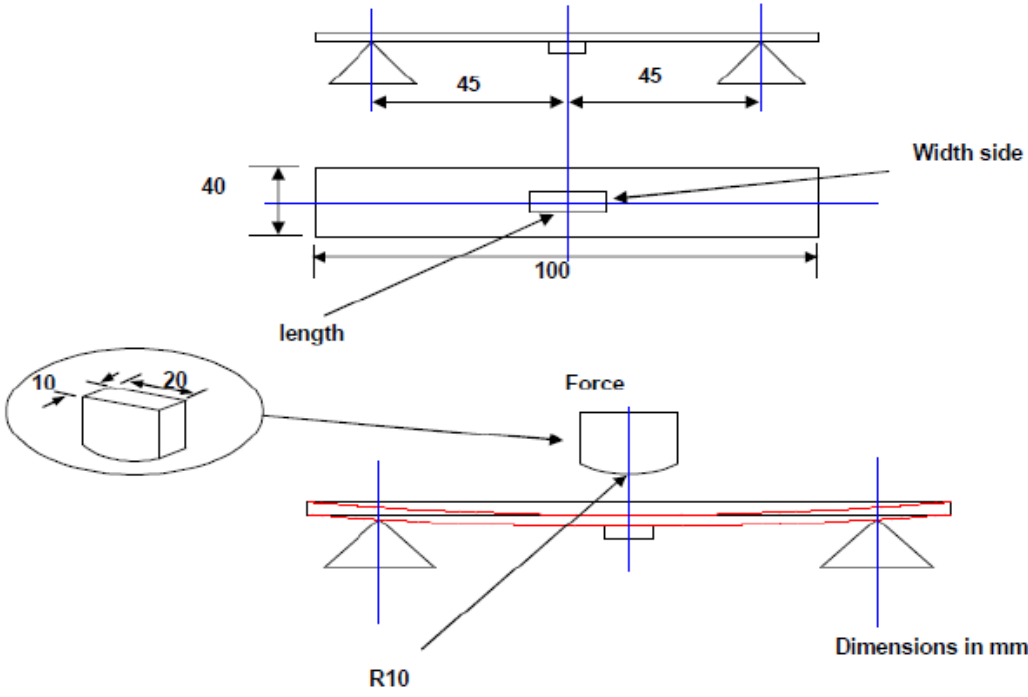
Item	Specifications	Test conditions
Solder ability	It can be connected on the Recommendation soldering condition.	Apply cream solder to the test circuit board . It is mounted on the recommendation soldering condition. Dip pads in flux and dip in solder pot (96.5 Sn/3.5 Ag solder) at 260°C ±5°C.
Terminal strength	The terminal electrode and the ferrite must not be damaged.	Solder a chip to test substrate , and then laterally apply a load 0.5Kg in the arrow direction. 
Strength on pc board bending	The terminal electrode and the ferrite must not be damaged.	Soldering a chip to a test substrate , bend the substrate by 2mm and then return.  Test board : Glass base epoxy multiplayer board pc board pattern. PC board pattern : Recommended PC board pattern.

Item	Specifications	Test conditions
High temperature	<p>Appearance : Ferrite shall not be damaged.</p> <p>Impedance: Within $\pm 20\%$ of the initial value.</p> <p>insulation resistance: $>10(M\Omega)$</p> <p>DC resistance : standard value inside.</p>	1000hrs.at rated operating temperature (e.g. 155°C part can be stored for 1000hrs.@ 155°C.Same applies for 125°C and 105°C. Unpowered. Measurement at 24 \pm 4 hours after test conclusion.
Biased Humidity		1000hours 85°C/85%RH. Unpowered. Measurement at 24 \pm 4hours after test conclusion.
Temperature Cycling		1000 cycles (-50°C to +155°C) Measurement at 24 \pm 4 hours after test conclusion. 30min maximum dwell time at each temperature extreme. 1 min. maximum transition time.
Operational Life		1000hrs. @155°C. If 105°C or 125°C part will be Tested at that temperature. Measurement at 24 \pm 4 hours after test conclusion
Mechanical Shock	Impedance: Within $\pm 20\%$ of the initial value.	<p>peak acceleration : 100 g's</p> <p>Duration of pulse : 6 ms</p> <p>Waveform : Half-sine</p> <p>Velocity change : 12.3 ft/sec</p> <p>Direction : X , Y , Z (3axes/3 times)</p>
Resistance to Solvents	No apparent damage	<p>Note: It is applicable to marked and/or coated components.</p> <p>Add Aqueous wash chemical OKEMCLEAN (A 6% concentrated Oakite cleaner) or equivalent. Do not use banned solvents.</p>
Vibration	Appearance : Ferrite shall not be damaged.	5g's for 20 minutes, 12 cycles each of 3 orientations. Test from 10-2000 Hz.
Resistance to Soldering Heat	The chip shall not crack. More than 75% of the terminal electrode shall be covered with solder.	<p>Solder temperature : 260 $\pm 5^\circ\text{C}$</p> <p>Dip time: 10 ± 1 seconds</p> <p>The chip shall not crack.</p> <p>More than 75% of the terminal electrode shall be covered with solder.</p>
Flammability		<p>Burning stops within 10 seconds on a vertical specimen;</p> <p>Drips of particles allowed as long as they are not inflamed.</p>



(5) RECOMMENDED SOLDERING CONDITIONS

(Please use this product by reflow soldering)

(5)-1 RECOMMENDED FOOTPRINT

Unit: mm

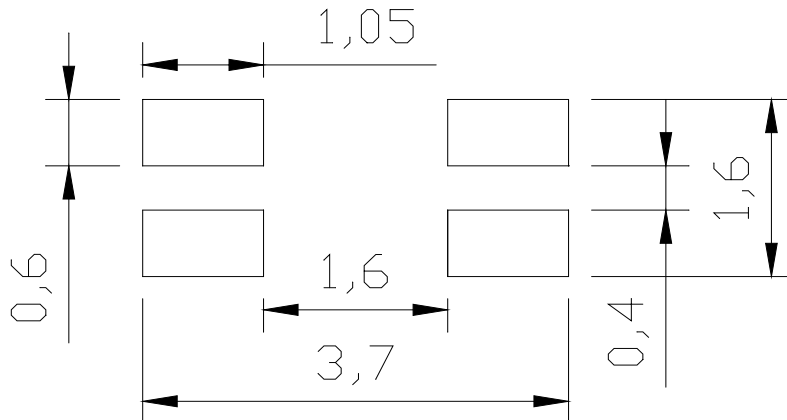

(5)-2 RECOMMENDED REFLOW PATTERN

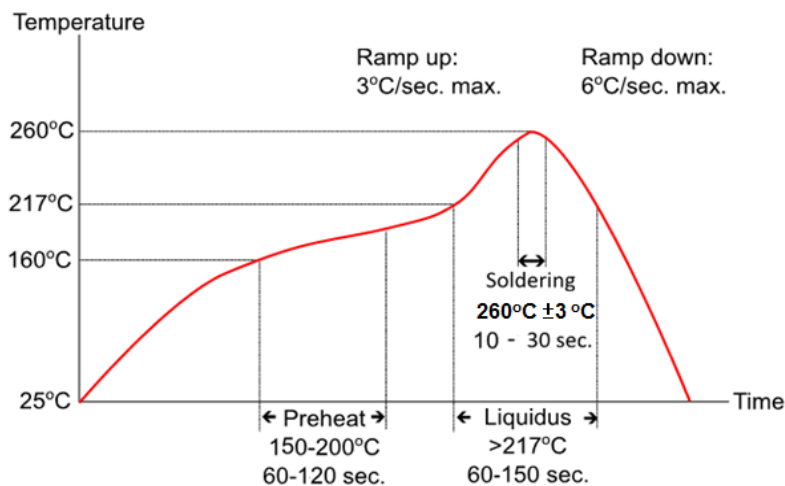

Ramp up rate: 3°C per second (max.)

Ramp down rate: 6°C per second (max.)

Preheat temperature: 150-200°C, 60-120 seconds

Liquidus temperature: above 217°C, 60-150 seconds

Peak temperature: 260°C ± 3°C, 10-30 seconds

(5)-3 IRON SOLDERING

Use a solder iron of less than 30W when soldering, do not allow the soldering iron tip directly touch the Ceramic body outside of terminal electrode.
3 seconds max. at 260°C.



MAG.LAYERS

(6) PACKAGING

(6)-1 CARRIER TAPE DIMENSIONS (mm)

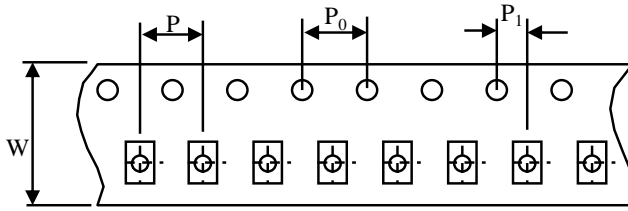

W	: 80	mm
P	: 4.0	mm
P_0	: 4.0	mm
P_1	: 2.0	mm

(6)-2 TAPING DIMENSIONS (mm)

There shall not continuation more than two vacancies of the product.

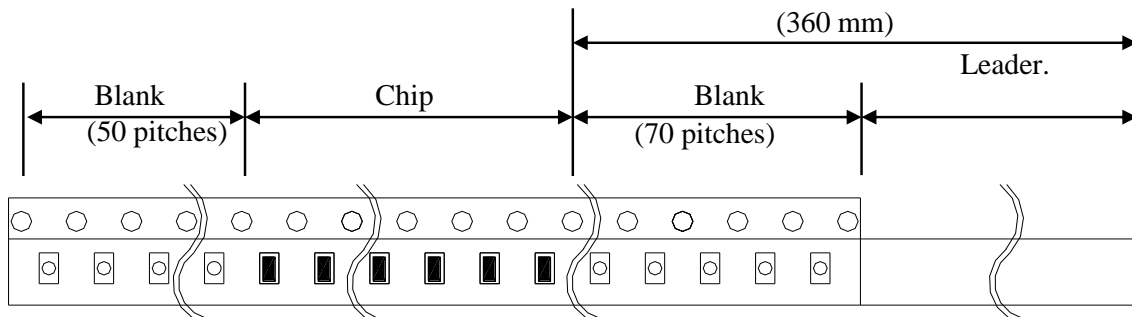

(6)-3 REEL DIMENSIONS

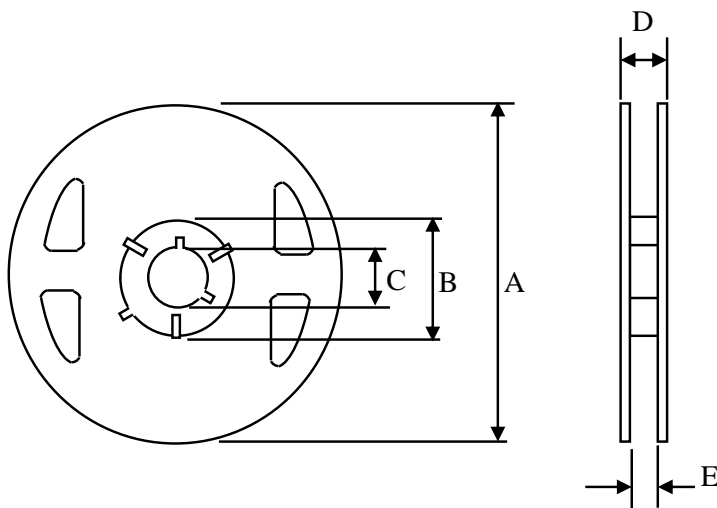

A	: 180	mm
B	: 60	mm
C	: 13.5	mm
D	: 15.5	mm
E	: 9.0	mm

(6)-4 COVER TAPE PEEL STRENGTH

The force for tearing off cover tape is 0.1~0.6(N) in the arrow direction at the following conditions:

Temperature : 5 ~ 35°C

Humidity : 45 ~ 85%

Atmospheric pressure : 860 ~ 1060 hpa

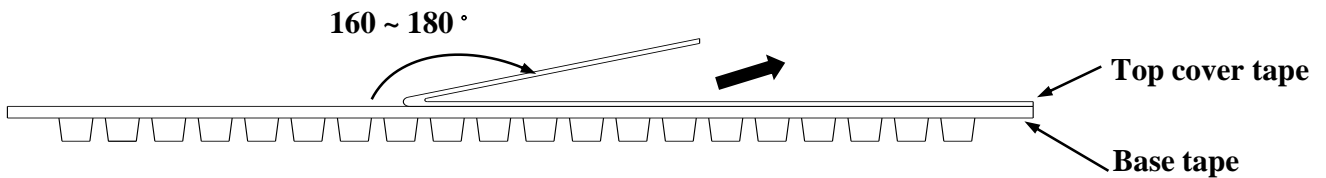

(6)-5 QUANTITY

2000 pcs/Reel

(6)-6 The products are packaged so that no damage will be sustained.

(7) ATTENTION IN CASE OF USING

In case of using product ,please avoid following matters:

Splashing water or salt water

Dew condenses

Toxic gas (Hydrogen sulfide, Sulfurous acid ,Chlorine, Ammonia)

Vibrations or shocks which exceed the specified condition

Please be careful for the stress to this product by board flexure or something after the mounting.



MAG.LAYERS

MCI-3216SH-SERIES

Page-7/7

TYPICAL ELECTRICAL CHARACTERISTICS

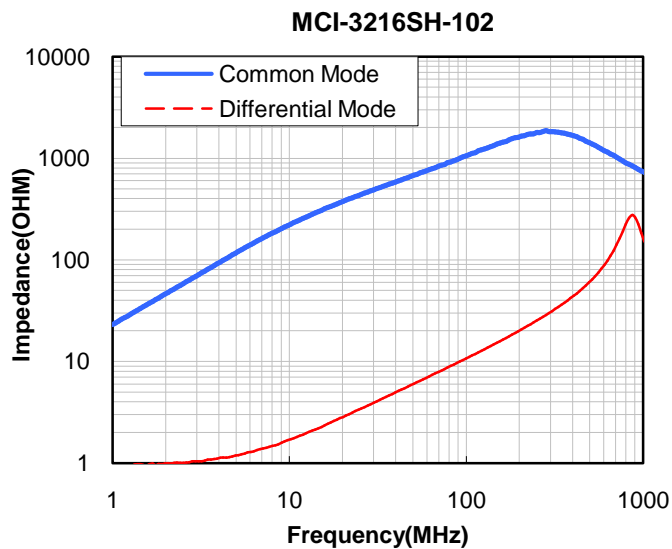
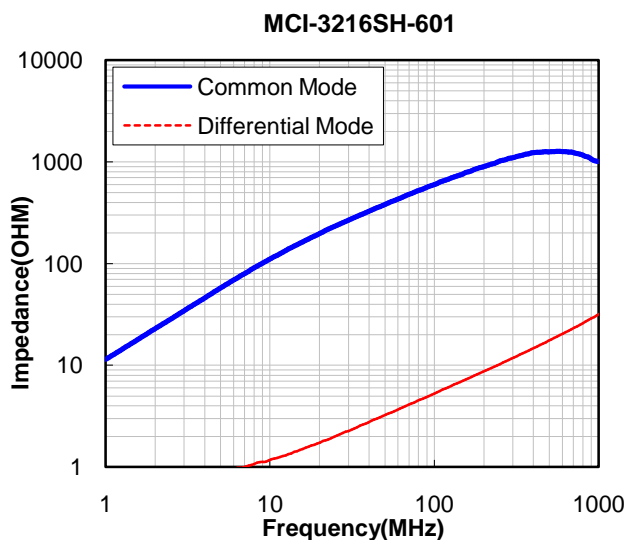
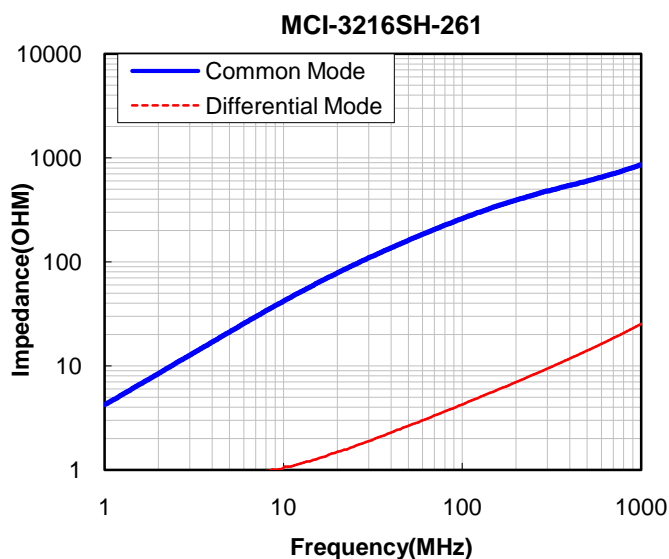
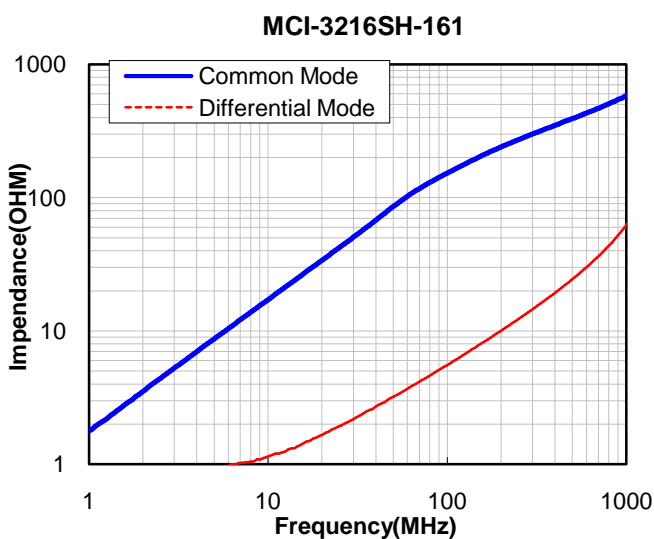
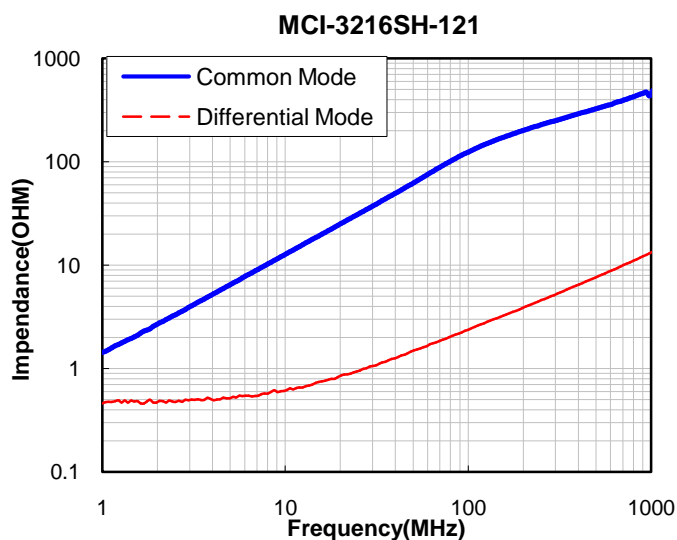
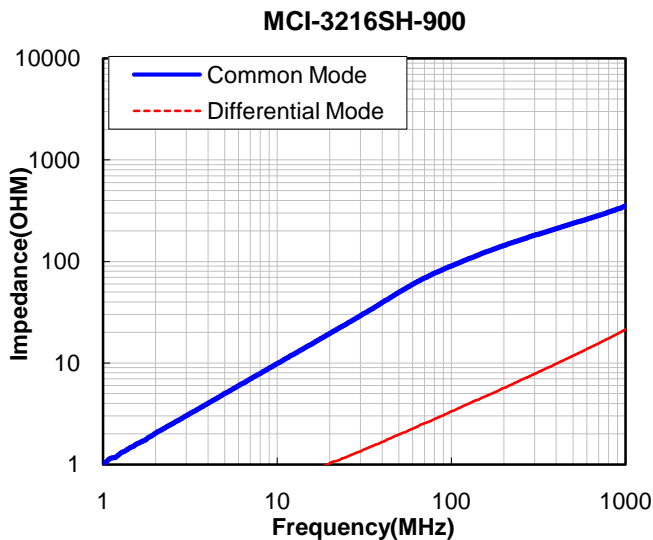

TYPICAL ELECTRICAL CHARACTERISTICS

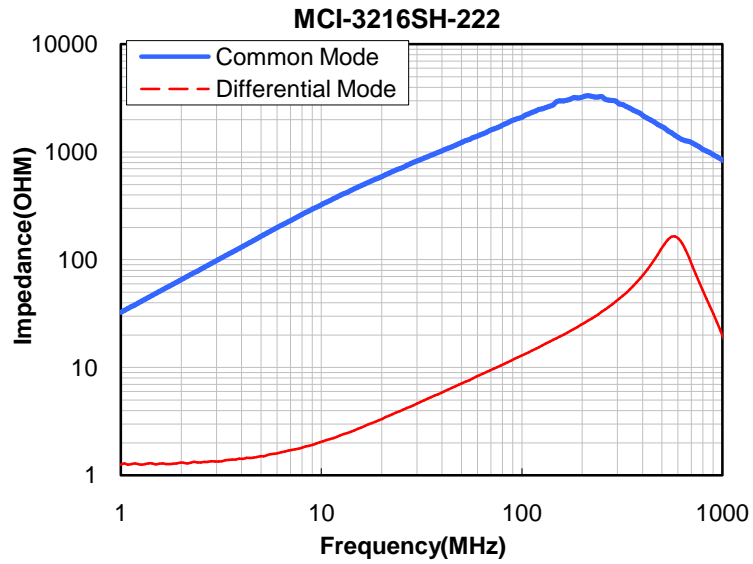

Please note that the contents may change without any prior notice due to reasons such as upgrading.