

SCOPE :

This specification applies to the Pb Free high current type SMD inductors for

MSI-110812V-SERIES- □- □□

Warn : This product series can't be used in synchronous rectification circuit that is over 24V.

PRODUCT IDENTIFICATION

MSI - 110812V - R22 M -E-□□

① ② ③ ④ ⑤

- ① Product Code
- ② Dimensions Code
- ③ Inductance Code
- ④ Tolerance Code
- ⑤ Inner Control Code

(1) SHAPES AND DIMENSIONS(mm)

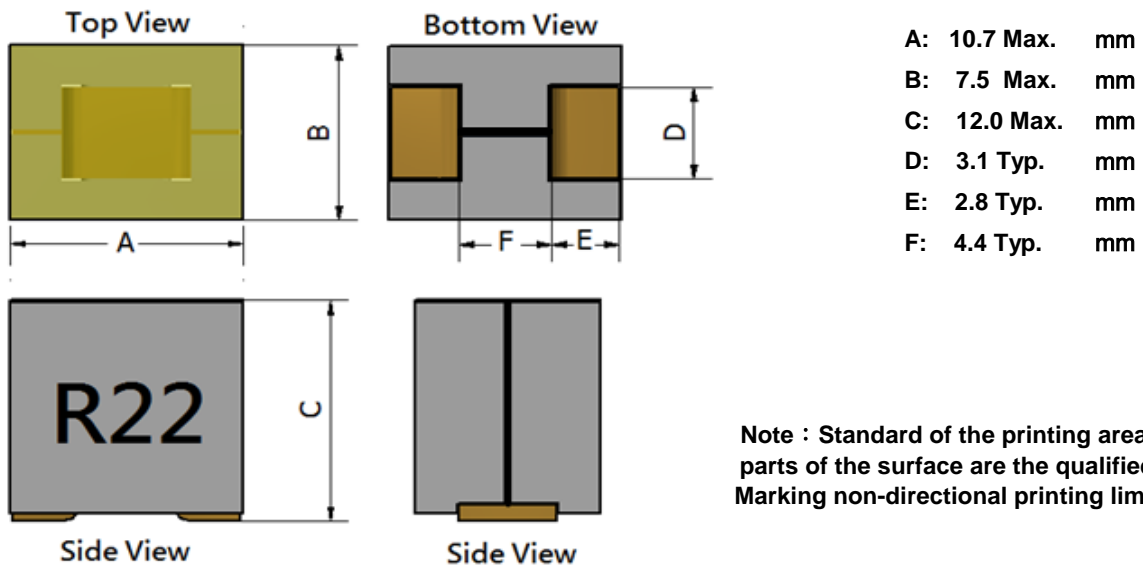

Note : Standard of the printing area, parts of the surface are the qualified Marking non-directional printing limit

(2) ELECTRICAL SPECIFICATIONS SEE TABLE 1

TEST INSTRUMENTS

L : HP 4284A PRECISION LCR METER (or equivalent)

RDC : CHROMA MODEL 16502 MILLIOHMMETER (or equivalent)

Isat : WK3255BQ+ WK3265B (or equivalent)

(3) CHARACTERISTICS

(3)-1 Operate temperature range $-40^{\circ}\text{C} \sim +125^{\circ}\text{C}$

(Including self temp. rise)

(3)-2 Storage temperature range $-40^{\circ}\text{C} \sim +125^{\circ}\text{C}$



MAG.LAYERS

TABLE 1

MAGLAYERS PT/NO.	Inductance L(μ H)	Percent Tolerance	Resistance RDC(m Ω)	Rated DC Current			Marking
				Isat1(A)	Isat2(A)	Irms(A)	
MSI-110812V-R15□-E	0.15	K,L,M	0.15 \pm 5%	115	97	75	R15
MSI-110812V-R18□-E	0.18	K,L,M	0.15 \pm 5%	85	72	75	R18
MSI-110812V-R22□-E	0.22	K,L,M	0.15 \pm 5%	75	64	75	R22
MSI-110812V-R25□-E	0.25	K,L,M	0.15 \pm 5%	66	56	75	R25
MSI-110812V-R27□-E	0.27	K,L,M	0.15 \pm 5%	60	51	75	R27
MSI-110812V-R30□-E	0.30	K,L,M	0.15 \pm 5%	55	45	75	R30
MSI-110812V-R32□-E	0.32	K,L,M	0.15 \pm 5%	51	43	75	R32

※ Test Frequency : 100kHz/1.0V

※ □ specify the inductance tolerance, K(\pm 10%), L(\pm 15%), M(\pm 20%)

※ Isat1 : Based on inductance change (Δ L/Lo : drop 20% Typ.)@ ambient temp. 25 $^{\circ}$ C

※ Isat2 : Based on inductance change (Δ L/Lo : drop 20% Typ.)@ ambient temp.100 $^{\circ}$ C

Irms : Based on temperature rise (Δ T : 40 $^{\circ}$ C TYP.)

Rated DC Current : The less value which is Isat1 or Irms .

RDC TEST POINT

The nominal DCR is measured from point

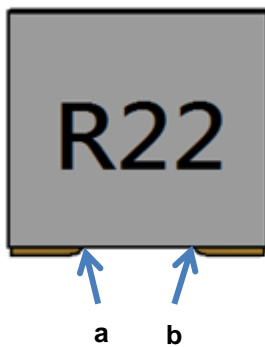

MAG.LAYERS

(4) RELIABILITY TEST METHOD ELECTRICAL

TEST ITEM	SPECIFICATION	TEST DETAILS
Temperature characteristics	$\Delta L/L20^{\circ}\text{C} \leq \pm 10\%$ 0~2000 ppm/ $^{\circ}\text{C}$	The test shall be performed after the sample has stabilized in an ambient temperature of -20 to +85 $^{\circ}\text{C}$, and the value calculated based on the value applicable in a normal temperature and normal humidity shall be $\Delta L/L20^{\circ}\text{C} \leq \pm 10\%$.

MECHANICAL

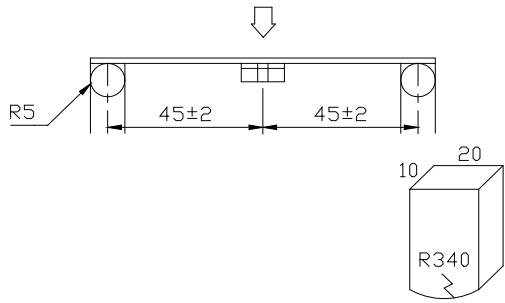
TEST ITEM	SPECIFICATION	TEST DETAILS
Substrate bending	$\Delta L/L_0 \leq \pm 5\%$ There shall be no mechanical damage or electrical damage.	<p>The sample shall be soldered onto the printed circuit board in figure 1 and a load applied until the figure in the arrow direction is made approximately 3mm. (keep time 30 seconds)</p> <p>PCB dimension shall the page 7/9</p> <p>F(Pressurization)</p>  <p>PRESSURE ROD figure-1</p>

MECHANICAL

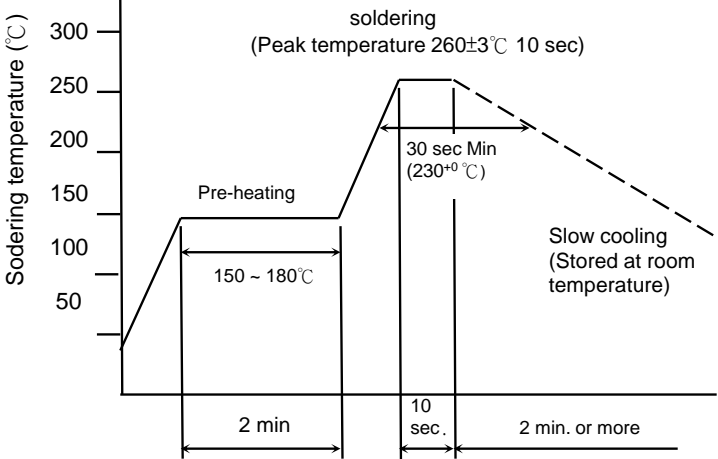
TEST ITEM	SPECIFICATION	
Vibration	$\Delta L/L_0 \leq \pm 5\%$ There shall be no mechanical damage.	The sample shall be soldered onto the printed circuit board and when a vibration having an amplitude of 1.52mm and a frequency of from 10 to 55Hz/1 minute repeated should be applied to the 3 directions (X,Y,Z) for 2 hours each. (A total of 6 hours)
Solderability	New solder More than 90%	Flux (rosin, isopropyl alcohol{JIS-K-1522}) shall be coated over the whole of the sample before hard, the sample shall then be preheated for about 2 minutes in a temperature of 130~150°C and after it has been immersed to a depth 0.5mm below for 3±0.2 seconds fully in molten solder M705 with a temperature of 245±5°C. More than 90% of the electrode sections shall be covered with new solder smoothly when the sample is taken out of the solder bath.
Resistance to Soldering heat (reflow soldering)	There shall be no damage or problems.	<p style="text-align: center;">Temperature profile of reflow soldering</p>  <p>The specimen shall be passed through the reflow oven with the condition shown in the above profile for 1 time. The specimen shall be stored at standard atmospheric conditions for 1 hour, after which the measurement shall be made.</p>



ENVIROMENT CHARACTERISTICS

TEST ITEM	SPECIFICATION																
High temperature storage	$\Delta L/L_0 \leq \pm 5\%$ There shall be no mechanical damage.	The sample shall be left for 96 ± 4 hours in an atmosphere with a temperature of 125°C and a normal humidity. Upon completion of the measurement shall be made after the sample has been left in a normal temperature and normal humidity for 1 hour.															
Low temperature storage	$\Delta L/L_0 \leq \pm 5\%$ There shall be no mechanical damage.	The sample shall be left for 96 ± 4 hours in an atmosphere with a temperature of $-40 \pm 3^\circ\text{C}$. Upon completion of the test, the measurement shall be made after the sample has been left in a normal temperature and normal humidity for 1 hour.															
Change of temperature	$\Delta L/L_0 \leq \pm 5\%$ There shall be no other damage of problems	The sample shall be subject to 5 continuous cycles, such as shown in the table 2 below and then it shall be subjected to standard atmospheric conditions for 1 hour, after which measurement shall be made. <div style="text-align: center;"> <table border="1" style="margin: auto;"> <caption>table 2</caption> <thead> <tr> <th></th> <th style="text-align: center;">Temperature</th> <th style="text-align: center;">Duration</th> </tr> </thead> <tbody> <tr> <td style="text-align: center;">1</td> <td style="text-align: center;">$-40 \pm 3^\circ\text{C}$ (Thermostat No.1)</td> <td style="text-align: center;">30 min.</td> </tr> <tr> <td style="text-align: center;">2</td> <td style="text-align: center;">Standard atmospheric</td> <td style="text-align: center;">No.1→No.2</td> </tr> <tr> <td style="text-align: center;">3</td> <td style="text-align: center;">$125 \pm 2^\circ\text{C}$ (Thermostat No.2)</td> <td style="text-align: center;">30 min.</td> </tr> <tr> <td style="text-align: center;">4</td> <td style="text-align: center;">Standard atmospheric</td> <td style="text-align: center;">No.2→No.1</td> </tr> </tbody> </table> </div>		Temperature	Duration	1	$-40 \pm 3^\circ\text{C}$ (Thermostat No.1)	30 min.	2	Standard atmospheric	No.1→No.2	3	$125 \pm 2^\circ\text{C}$ (Thermostat No.2)	30 min.	4	Standard atmospheric	No.2→No.1
	Temperature	Duration															
1	$-40 \pm 3^\circ\text{C}$ (Thermostat No.1)	30 min.															
2	Standard atmospheric	No.1→No.2															
3	$125 \pm 2^\circ\text{C}$ (Thermostat No.2)	30 min.															
4	Standard atmospheric	No.2→No.1															
Moisture storage	$\Delta L/L_0 \leq \pm 5\%$ There shall be no mechanical damage.	The sample shall be left for 96 ± 4 hours in a temperature of $40 \pm 2^\circ\text{C}$ and a humidity(RH) of 90~95%. Upon completion of the test, the measurement shall be made after the sample has been left in a normal temperature and normal humidity more than 1 hour.															
Test conditions : The sample shall be reflow soldered onto the printed circuit board in every test.																	

(5) LAND DIMENSION (Ref.)

PCB: GLASS EPOXY $t=1.6\text{mm}$

(5)-1 LAND PATTERN DIMENSIONS(mm)

(STANDARD PATTERN)

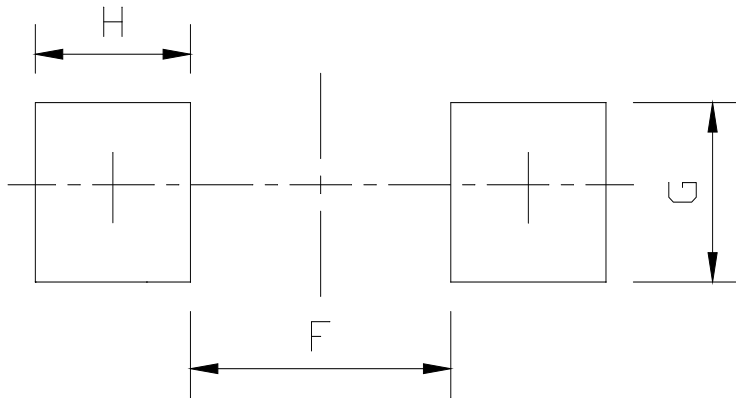

F : 3.7
G : 3.6
H : 3.6

(5)-2 SUBSTRATE BENDING TEST BENDING TEST BOARD

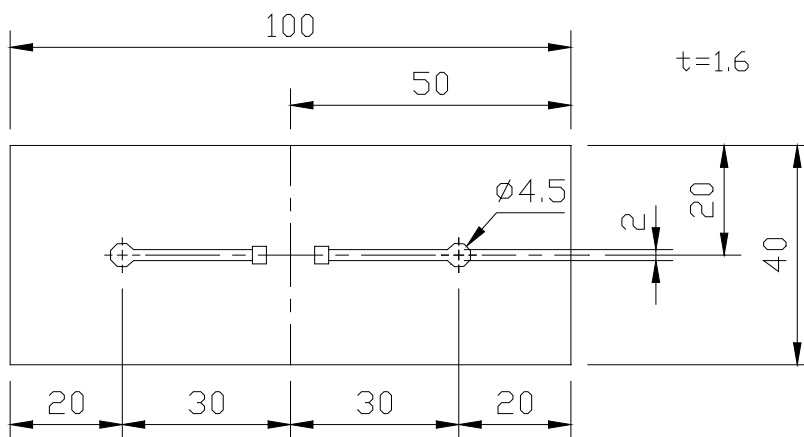

(6) PACKAGING

(6)-1 CARRIER TAPE DIMENSIONS (mm)

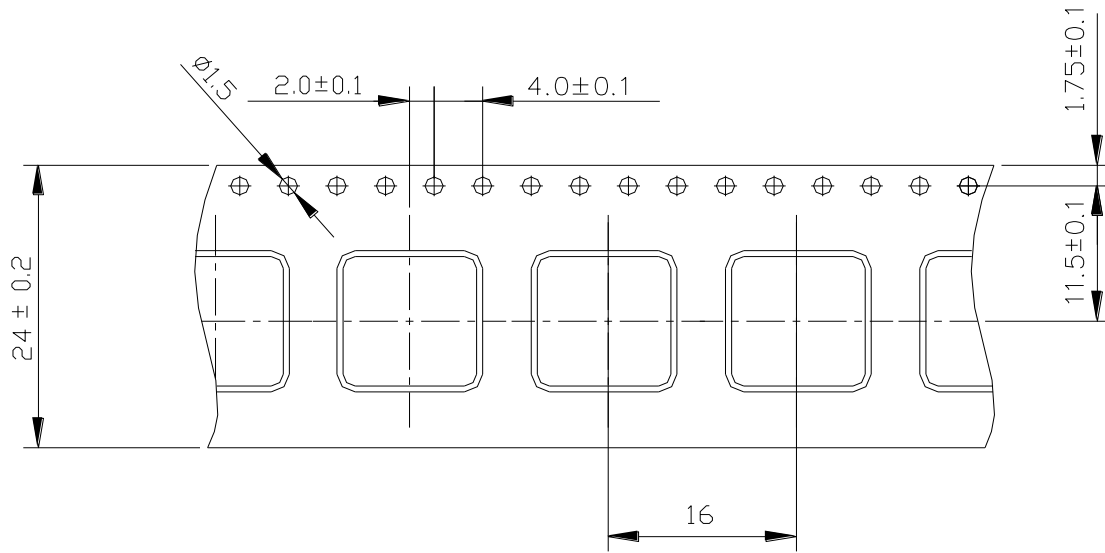

(6)-2 TAPING DIMENSIONS (mm)

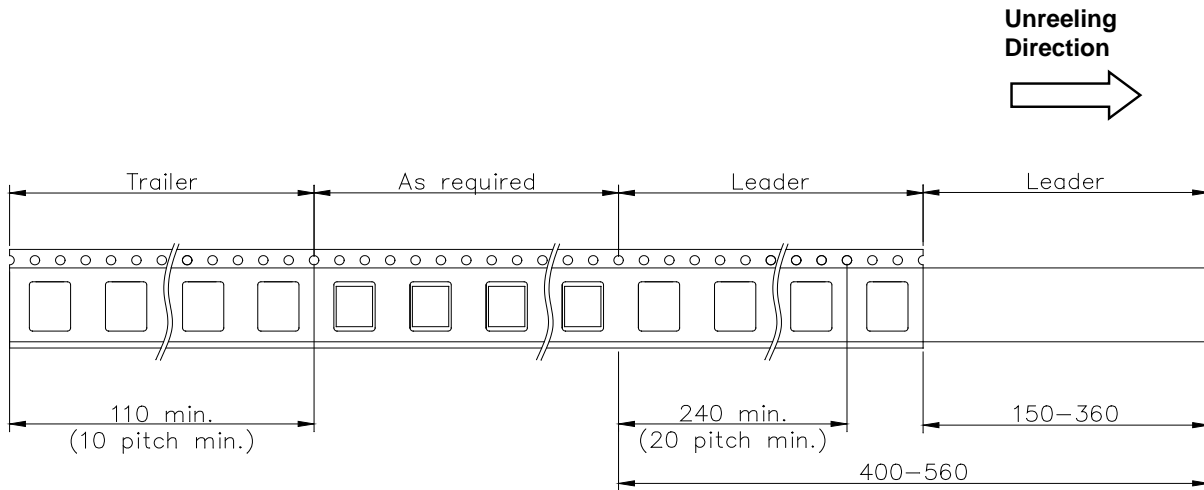

(6)-3 REEL DIMENSIONS (mm)

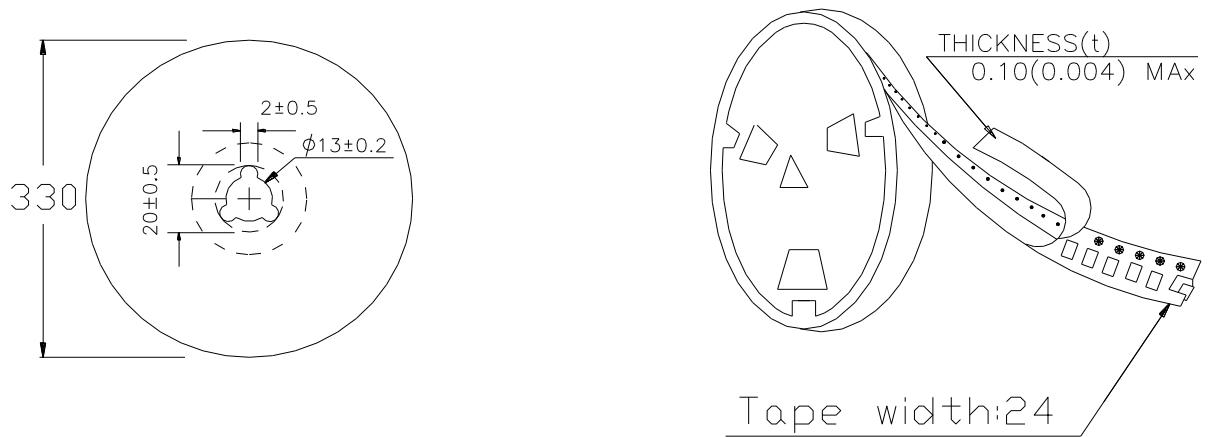

(6)-4 QUANTITY

300 pcs/Reel

The products are packaged so that no damage will be sustained.

Please note that the contents may change without any prior notice due to reasons such as upgrading.



MAG.LAYERS

TYPICAL ELECTRICAL CHARACTERISTICS

INDUCTANCE vs. DC CURRENT @100kHz/1.0V

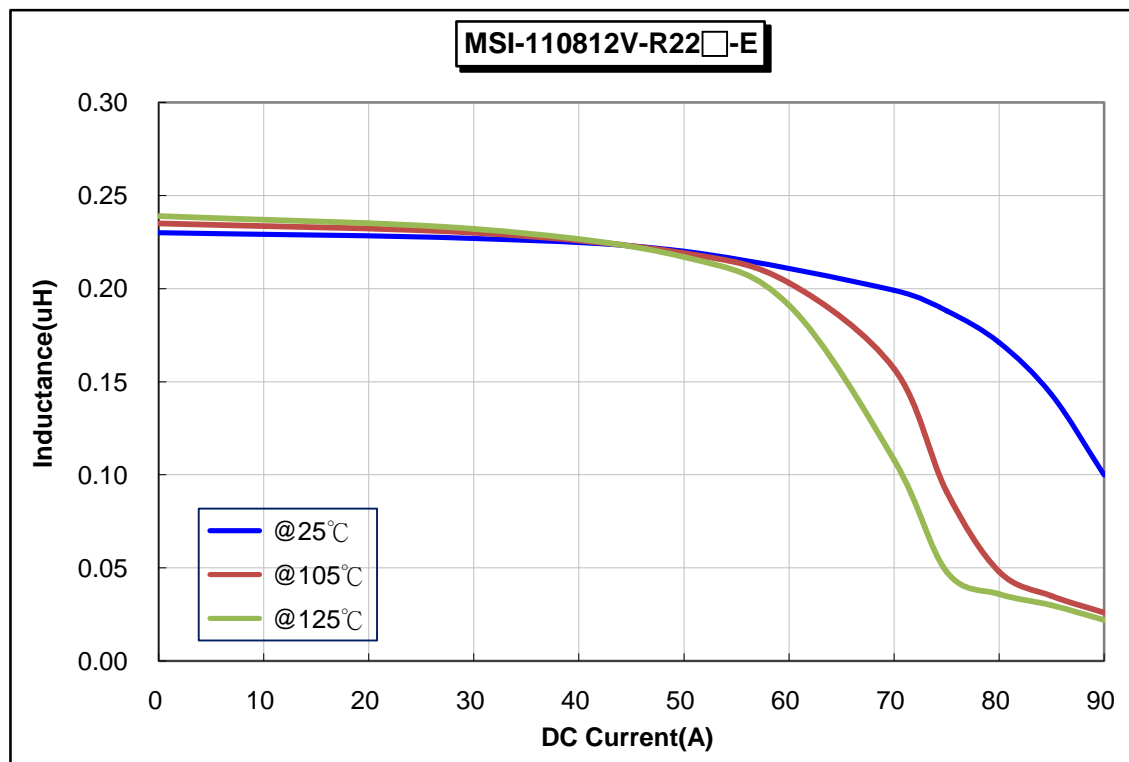
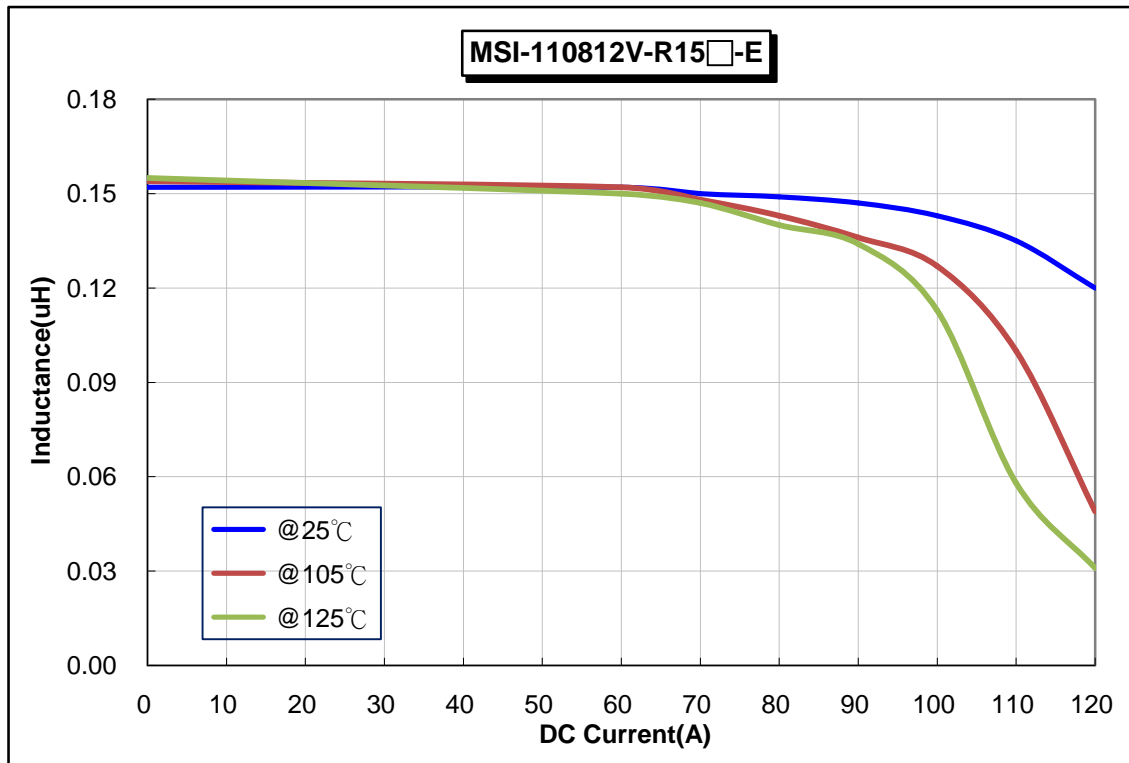

TYPICAL ELECTRICAL CHARACTERISTICS

INDUCTANCE vs. DC CURRENT@100kHz/1.0V

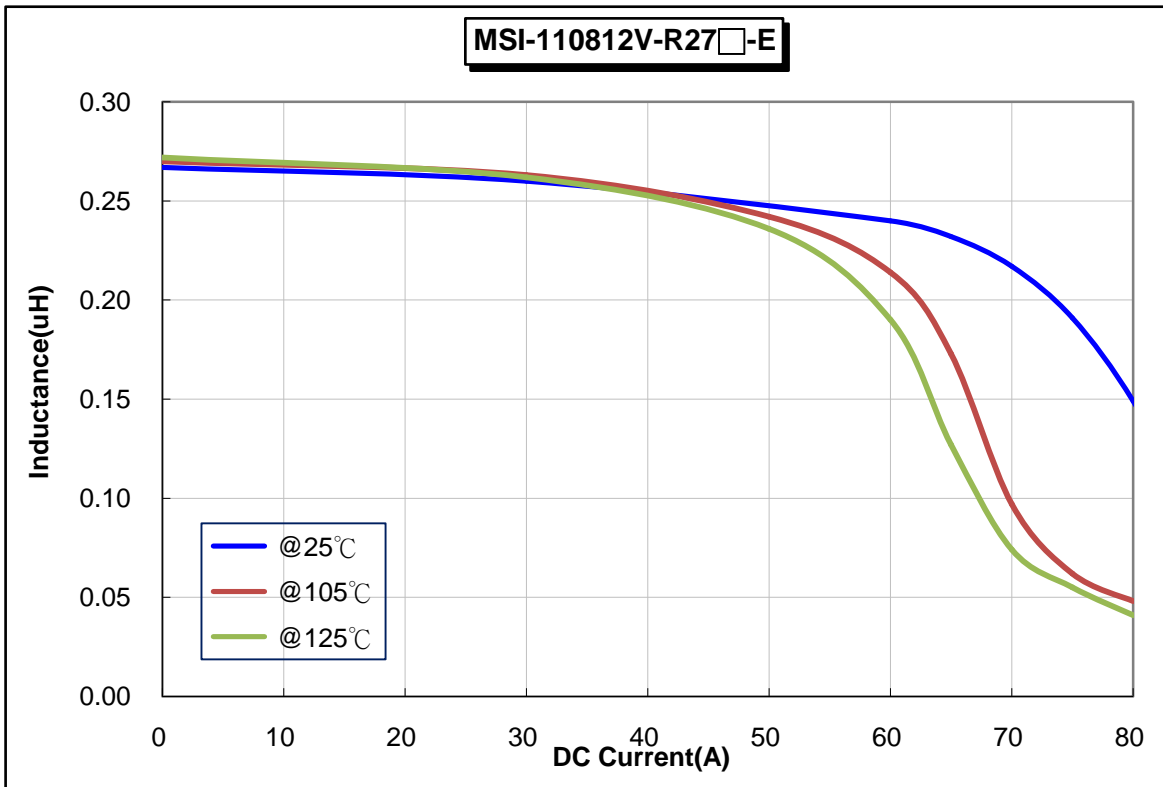
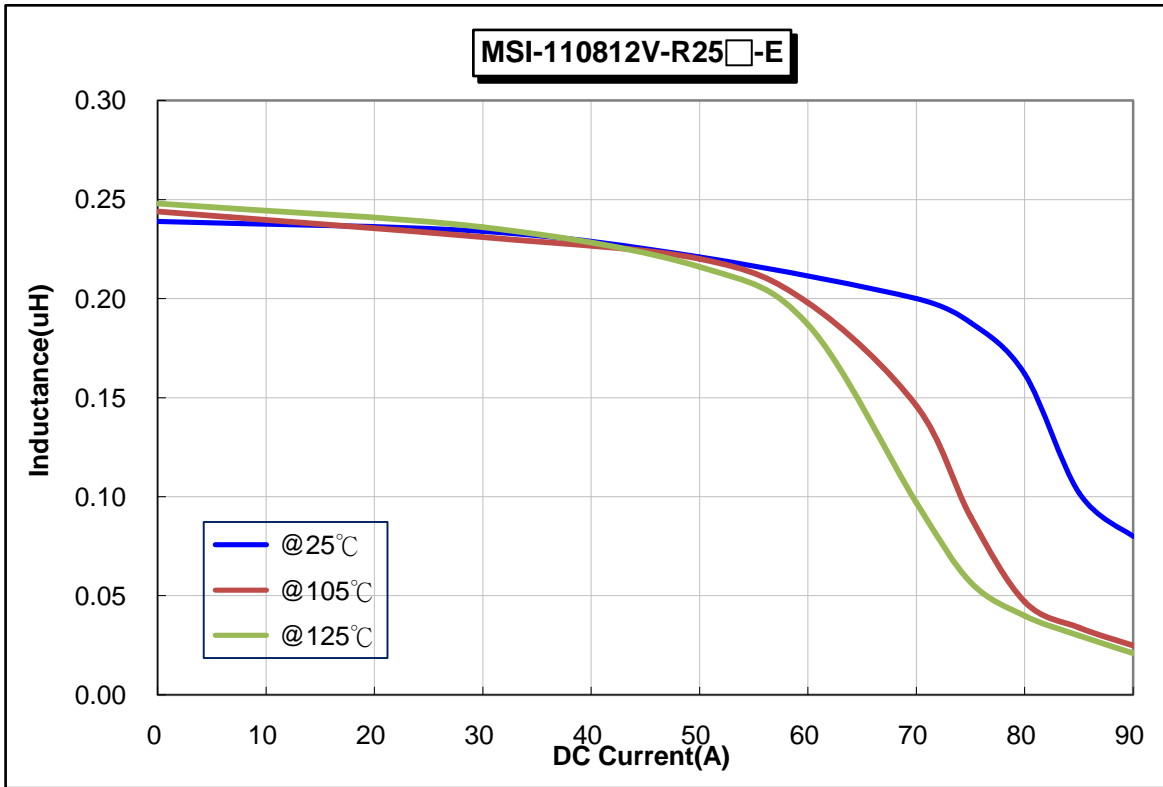

TYPICAL ELECTRICAL CHARACTERISTICS

INDUCTANCE vs. DC CURRENT@100kHz/1.0V

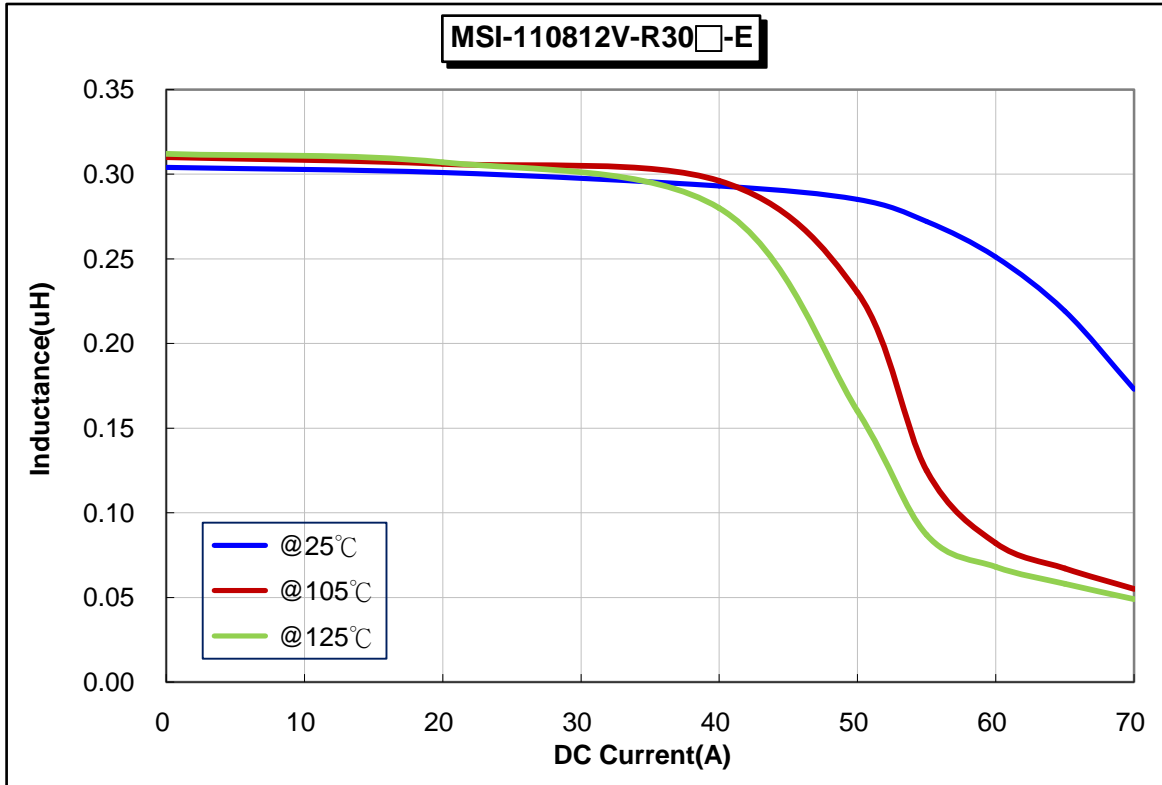

TYPICAL ELECTRICAL CHARACTERISTICS

Temperature Rise vs. DC Current

