

I . SCOPE :

This specification applies to the Pb Free high current type SMD Coupled inductors for

MSI-280904CP-SERIES-□-□□

Warn : It is here not to use synchronous rectification curcuit !

PRODUCT IDENTIFICATION

MSI - 280904CP - R30 N - E - □□

① ② ③ ④ ⑤

- ① Product Code
- ② Dimensions Code
- ③ Inductance Code
- ④ Tolerance Code
- ⑤ Inner Control Code

(1) SHAPES AND DIMENSIONS

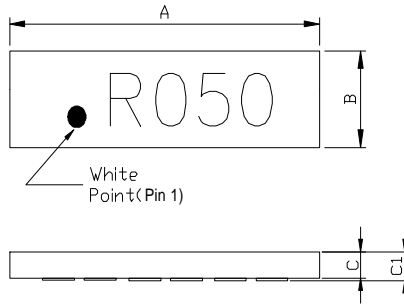

A: 27.3±0.5	mm
B: 9.0±0.5	mm
C: 4.0 Max.	mm
C1: 4.2 Max.	mm
D: 2.5±0.15	mm
E: 7.3±0.25	mm
F: 3.3±0.15	mm

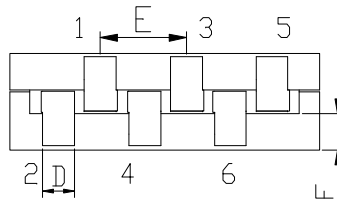

(2) ELECTRICAL SPECIFICATIONS

SEE TABLE 1

TEST INSTRUMENTS

- L : HP 4285A PRECISION LCR METER (or equivalent)
- RDC : CHROMA MODEL 16502 MILLIOHMMETER (or equivalent)
- IDC1 : CH3302/G LCR METER
- CH1320,CH1320S BIAS CURRENT SOURCE(or equivalent)

(3) CHARACTERISTICS

- (3)-1 Ambient temperature + 60°C Max.
- (3)-2 Operate temperature range - 40°C ~ + 125°C
(Including self temp. rise)
- (3)-3 Storage temperature range - 40°C ~ + 125°C



MAG.LAYERS

TABLE

MAGLAYERS	Leakage Inductance(nH) Pin(2-5)@(1-4,3-6 short)/Phase	Inductance(μ H) Pin(1-2) Pin(3-4) Pin(5-6)	RDC(m Ω) Pin(1-2) Pin(3-4) Pin(5-6)	Rated DC Current (Max.)	
				Isat/Phase(A) Pin(2-5) @1-4, 3-6 short)	Irms/Phase(A) Pin(1-2) Pin(3-4) Pin(5-6)
MSI-280904CP-R30N-E-□□	50 \pm 20%	0.3 \pm 30%	0.285 \pm 10%	55	50

*Inductance Test Frequency : 1MHz/1V

*L BIAS Test Frequency:100kHz/1V

※ Isat/Phase : Based on inductance change (Δ L/Lo : drop 20% Max.) @ ambient temp. 25°C

Irms : Based on temperature rise (Δ T : 40°C TYP.)

RDC TEST POINT

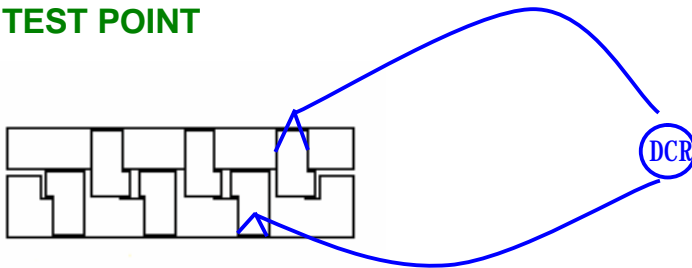

SCHEMATIC

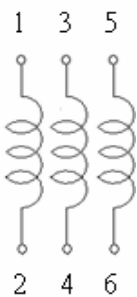

MAG.LAYERS

(4) RELIABILITY TEST METHOD MECHANICAL

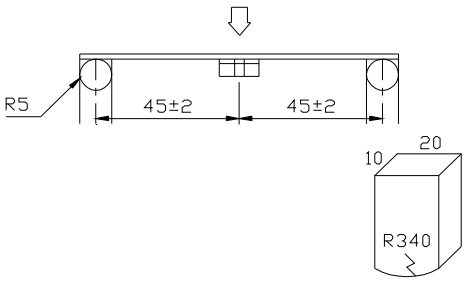
	SPECIFICATION	TEST DETAILS
Substrate bending	$\Delta L/L_0 \leq \pm 5\%$ no mechanical damage or electrical damage.	<p>The sample shall be soldered onto the printed circuit board in figure 1 and a load applied until the figure in the arrow direction is made approximately 3mm.(keep time 30 seconds) PCB dimension shall the page 7/9</p> <p>F(Pressurization)</p>  <p>PRESSURE ROD figure-1</p>
Vibration	$\Delta L/L_0 \leq \pm 5\%$ There shall be no mechanical damage.	<p>The sample shall be soldered onto the printed circuit board and when a vibration having an amplitude of 1.52mm and a frequency of from 10 to 55Hz/1 minute repeated should be applied to the 3 directions (X,Y,Z) for 2 hours each. (A total of 6 hours)</p>
Solderability	New solder More than 90%	<p>Flux (rosin, isopropyl alcohol{JIS-K-1522}) shall be coated over the whole of the sample before hard, the sample shall then be preheated for about 2 minutes in a temperature of 130~150°C and after it has been immersed to a depth 0.5mm below for 3±0.2 seconds fully in molten solder M705 with a temperature of 245±5°C.</p> <p>More than 90% of the electrode sections shall be covered with new solder smoothly when the sample is taken out of the solder bath.</p>

MECHANICAL

TEST ITEM	SPECIFICATION	
<p>Soldering heat (reflow soldering)</p>	<p>There shall be no damage or problems.</p>	<p style="text-align: center;">Temperature profile of reflow soldering</p> <p>The specimen shall be passed through the reflow oven with the condition shown in the above profile for 1 time.</p> <p>The specimen shall be stored at standard atmospheric conditions for 1 hour, after which the measurement shall be made.</p>

ELECTRICAL

TEST ITEM	SPECIFICATION	TEST DETAILS
<p>Temperature characteristics</p>	<p>$\Delta L/L20^{\circ}\text{C} \leq \pm 10\%$ $0 \sim 2000 \text{ ppm}/^{\circ}\text{C}$</p>	<p>The test shall be performed after the sample has stabilized in calculated based on the value applicable in a normal temperature and normal humidity shall be $\Delta L/L20^{\circ}\text{C} \leq \pm 10\%$.</p>



ENVIROMENT CHARACTERISTICS

TEST ITEM	SPECIFICATION																
storage	$\Delta L/Lo \leq \pm 5\%$ There shall be damage.	The sample shall be left for 96 ± 4 hours in an atmosphere with a temperature of 125°C and a normal humidity. Upon completion of the measurement shall be made after the sample has been left in a normal temperature and normal humidity for 1 hour.															
Low temperature storage	$\Delta L/Lo \leq \pm 5\%$ There shall be no mechanical damage.	The sample shall be left for 96 ± 4 hours in an atmosphere with a temperature of $-25 \pm 3^\circ\text{C}$. Upon completion of the test, the measurement shall be made after the sample has been left in a normal temperature and normal humidity for 1 hour.															
Change of temperature	$\Delta L/Lo \leq \pm 5\%$ There shall be no other dama- ge of problems	The sample shall be subject to 5 continuous cycles, such as shown in the table 2 below and then it shall be subjected to standard atmospheric conditions for 1 hour, after which measurement shall be made. <div style="text-align: center;"> table 2 <table border="1" style="margin-left: auto; margin-right: auto;"> <thead> <tr> <th></th> <th style="text-align: center;">Temperature</th> <th style="text-align: center;">Duration</th> </tr> </thead> <tbody> <tr> <td style="text-align: center;">1</td> <td style="text-align: center;">$-25 \pm 3^\circ\text{C}$ (Thermostat No.1)</td> <td style="text-align: center;">30 min.</td> </tr> <tr> <td style="text-align: center;">2</td> <td style="text-align: center;">Standard atmospheric</td> <td style="text-align: center;">No.1→No.2</td> </tr> <tr> <td style="text-align: center;">3</td> <td style="text-align: center;"> (Thermostat No.2)</td> <td style="text-align: center;">30 min.</td> </tr> <tr> <td style="text-align: center;">4</td> <td style="text-align: center;">Standard atmospheric</td> <td style="text-align: center;">No.2→No.1</td> </tr> </tbody> </table> </div>		Temperature	Duration	1	$-25 \pm 3^\circ\text{C}$ (Thermostat No.1)	30 min.	2	Standard atmospheric	No.1→No.2	3	 (Thermostat No.2)	30 min.	4	Standard atmospheric	No.2→No.1
	Temperature	Duration															
1	$-25 \pm 3^\circ\text{C}$ (Thermostat No.1)	30 min.															
2	Standard atmospheric	No.1→No.2															
3	 (Thermostat No.2)	30 min.															
4	Standard atmospheric	No.2→No.1															
Moisture storage	$\Delta L/Lo \leq \pm 5\%$ There shall be no mechanical damage.	The sample shall be left for 96 ± 4 hours in a temperature of $40 \pm 2^\circ\text{C}$ and a humidity(RH) of 90~95%. Upon completion of the test, the measurement shall be made after the sample has been left in a normal temperature and normal humidity more than 1 hour.															
Test conditions : The sample shall be reflow soldered onto the printed circuit board in every test.																	

(5) LAND DIMENSION (Ref.)

(5)-1 LAND PATTERN DIMENSIONS(mm)

Unit : mm

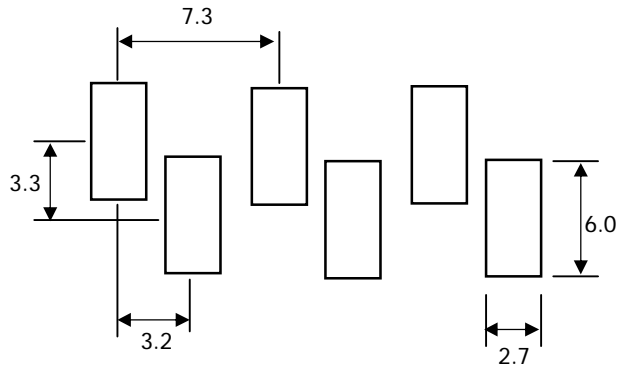

(6) PACKAGING

(6)-1 CARRIER TAPE DIMENSIONS (mm)

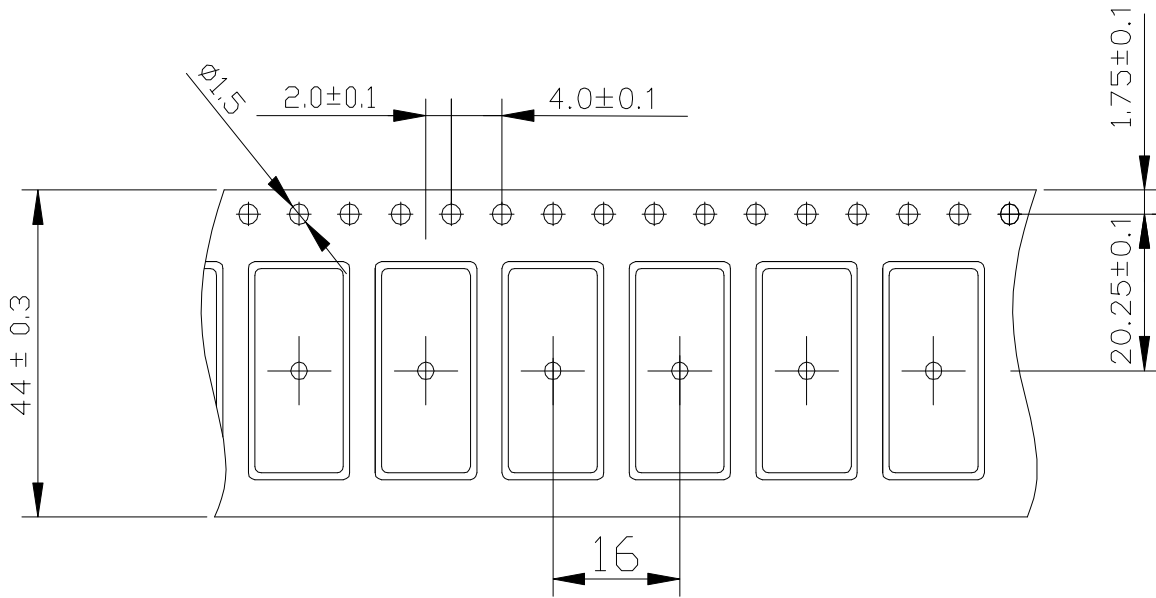

(6)-2 TAPING DIMENSIONS (mm)

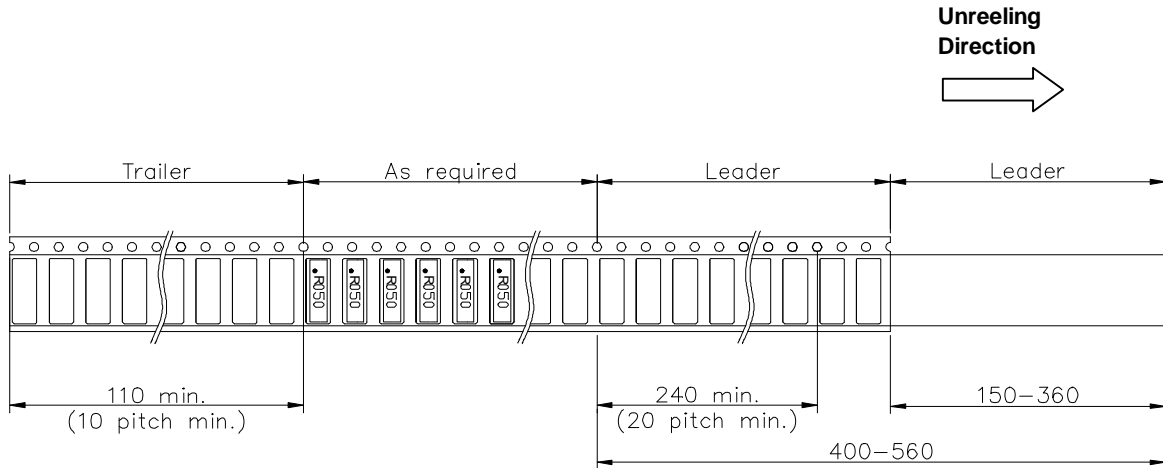

MAG.LAYERS

(6)-3 REEL DIMENSIONS (mm)

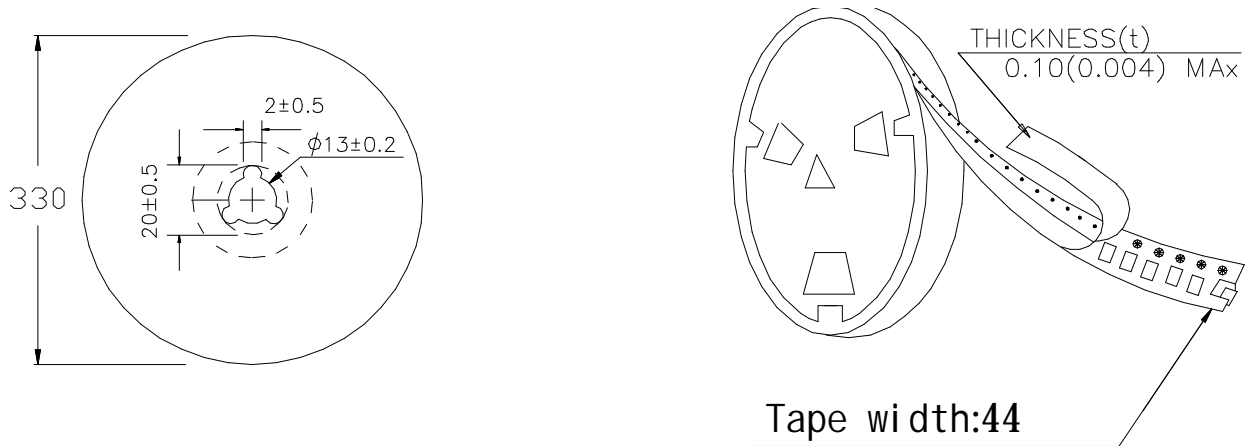

(6)-4 QUANTITY

800 pcs/Reel

The products are packaged so that no damage will be sustained.

TYPICAL ELECTRICAL CHARACTERISTICS

INDUCTANCE vs. DC CURRENT

L(1-6)@(2-3, 4-5 Short) 100kHz/1V, Ambient Temperature : 25°C/100°C/125°C

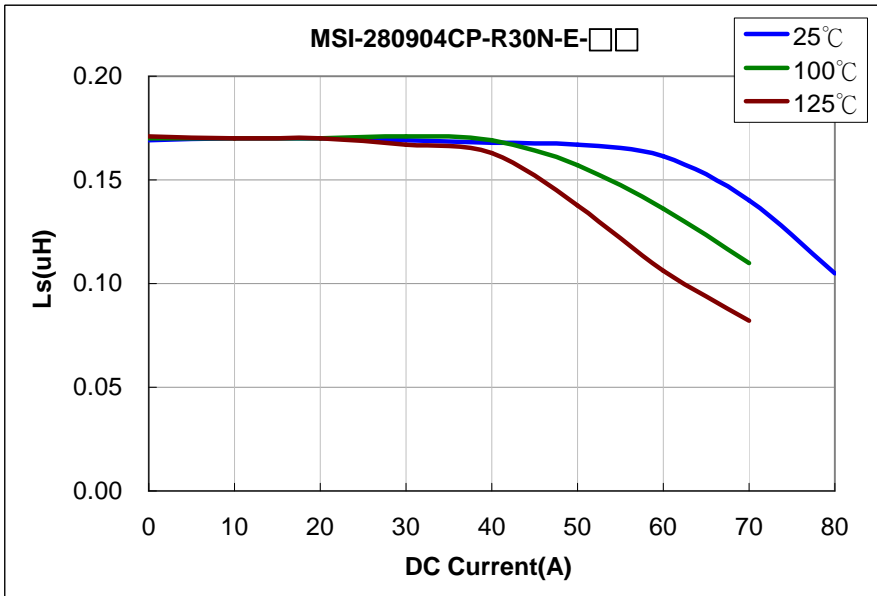

Temperature Rise vs. DC Current 【Pin (1-2)】

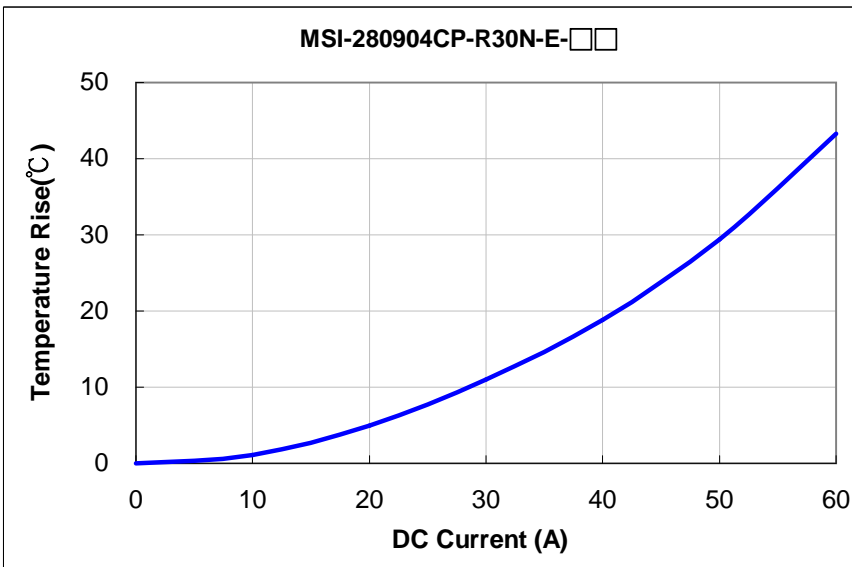

TYPICAL ELECTRICAL CHARACTERISTICS

Inductance vs Frequency

L(1-6)@(2-3, 4-5 Short) @Ambient Temperature : 25°C

