



Networking Communication Components

RT Series

LAN Transformer

Part number: RT11H03

Part name :10/ 100 Transformer Single Port

Feature

- Compliant and peak reflow temperature rating 245°C .
- Meets IEEE802.3 specification.
- Excellent common mode noise suppression.
- Packaging specification is tube.
(RT11H□□ : Tube)

Part number code

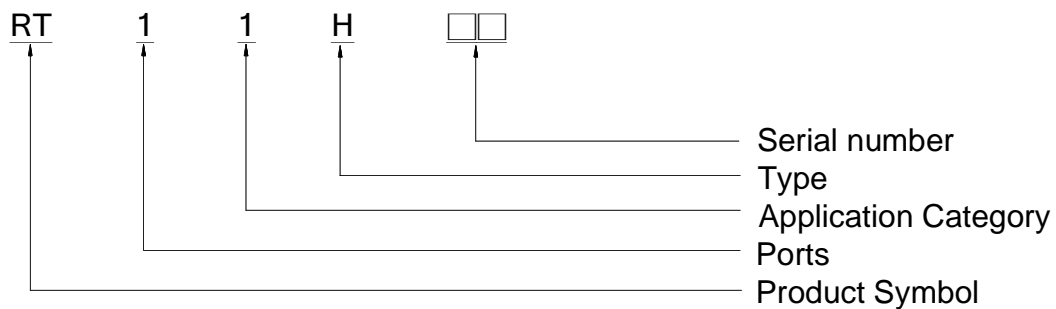

Mechanical Dimension and Marking

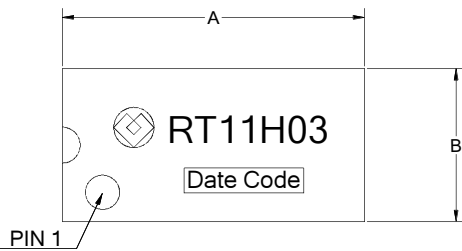

UNIT	mm	inch
A	20.60 +0.254/-0.254	0.811 +0.010/-0.010
B	9.70 +0.254/-0.254	0.382 +0.010/-0.010
C	6.20 +0.254/-0.254	0.244 +0.010/-0.010
D	3.20 +0.127/-0.127	0.126 +0.005/-0.005
E	0.50 +0.127/-0.127	0.020 +0.005/-0.005
F	2.54 +0.127/-0.127	0.100 +0.005/-0.005
G	17.78 +0.254/-0.254	0.700 +0.010/-0.010
H	7.62 +0.254/-0.254	0.300 +0.010/-0.010

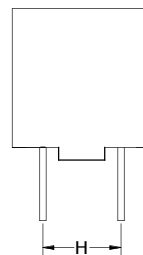
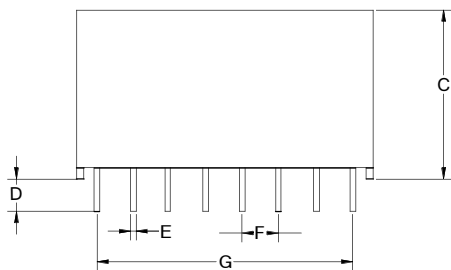
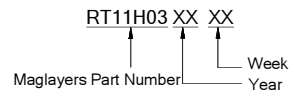

Suggested Land Pattern

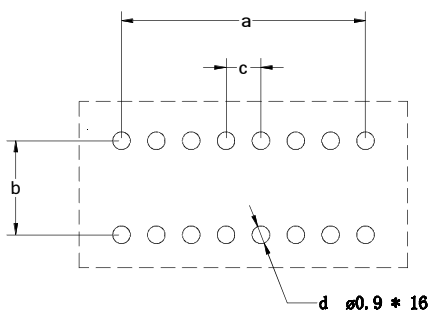

UNIT	mm	inch
a	17.78	0.700
b	7.62	0.300
c	2.54	0.100
d	$\varnothing 0.90$	$\varnothing 0.035$

Drawn	Yuxuan.Xiang	Designed	Yuxuan.Xiang	Approved	James.Cheng
-------	--------------	----------	--------------	----------	-------------

Schematics

RT11H03

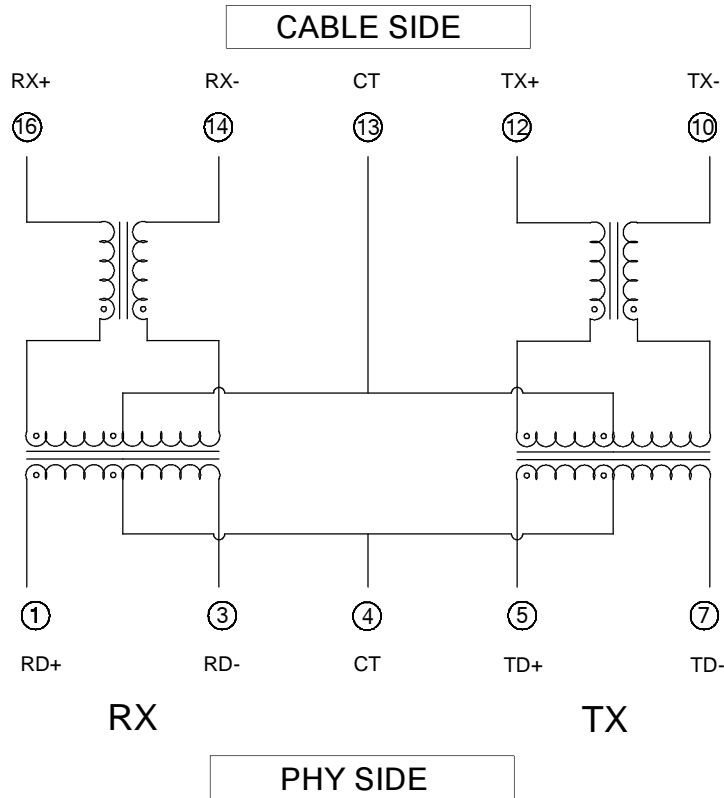

N.C. pins : ② ⑥ ⑧ ⑨ ⑪ ⑮

Electrical Specification @ 25°C, Humidity 65% RH

Inductance @ Phy side(OCL)
100KHz, 0.1V, 8mA DC Bias
350uH MIN

Part Number	Turn Ratio		Insertion Loss dB MAX	Return Loss dB MIN				CMRR dB MIN	Crosstalk dB MIN	Hipot Vrms, Sec
	TX	RX		0.5-30 MHz	40 MHz	60 MHz	80 MHz			
			1-100 MHz					0.1-100 MHz	0.1-100 MHz	Pri To Sec @60Hz,1mA
RT11H03	1:1±5%	1:1±5%	-1.1dB	-18dB	-15dB	-13dB	-11dB	-30dB	-35dB	1500, 60

Operating Temperature: 0°C to +70°C.
Storage Temperature: -25°C to +105°C
JSDEC Moisture: Level 1.

Wave Soldering

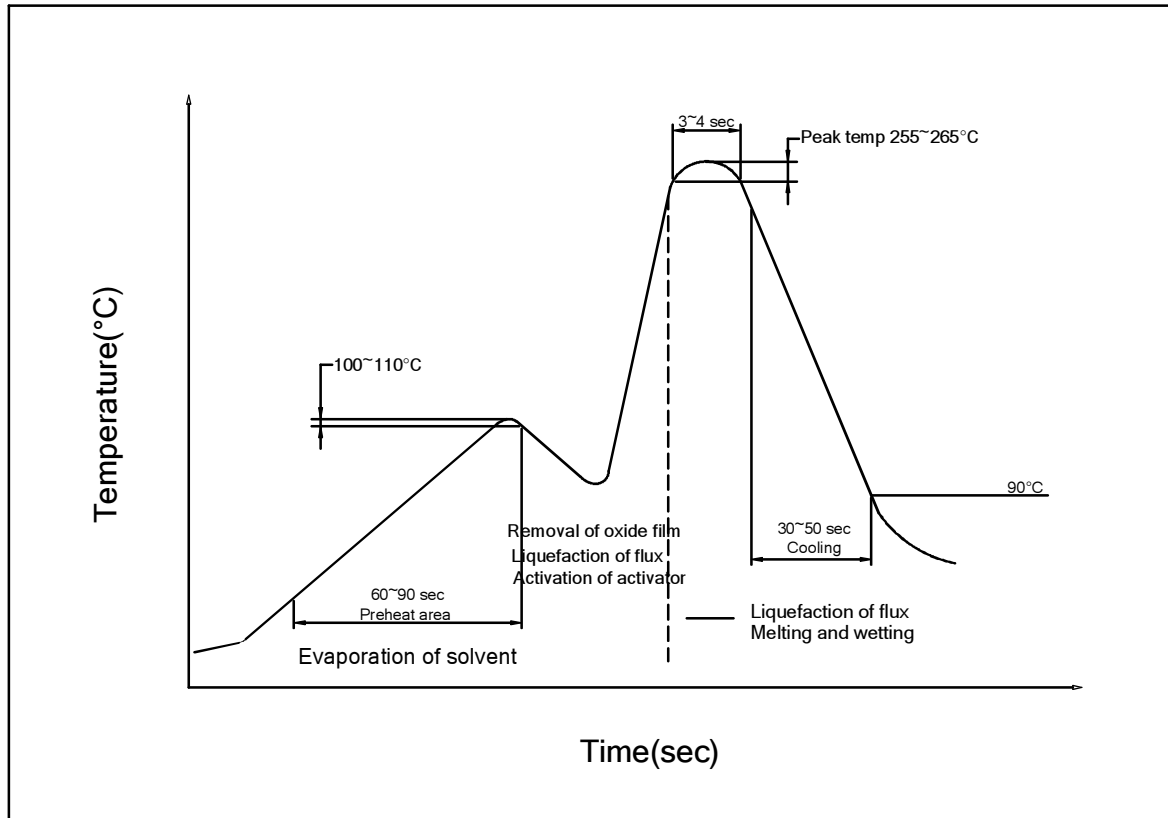

- Tip Temperature :265°C MAX.
- Tip Temperature Time: 4sec MAX.