

## SCOPE :

This specification applies to the Pb Free high current type SMD inductors for  
MSCH-2015C-SERIES

### PRODUCT IDENTIFICATION

**MSCH - 2015C - 100 K**

①      ②      ③    ④

- ① Product Code
- ② Dimensions Code
- ③ Inductance Code
- ④ Tolerance Code

## (1) SHAPES AND DIMENSIONS

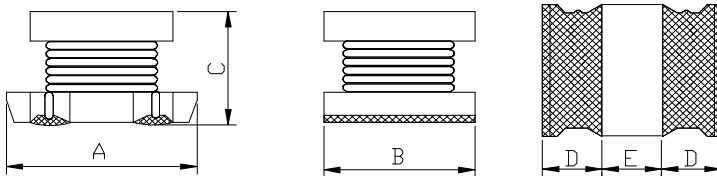

A: 2.0±0.3	mm
B: 1.5±0.2	mm
C: 1.7±0.3	mm
D: 0.6Typ.	mm
E: 0.8Typ.	mm

## (2) ELECTRICAL SPECIFICATIONS

SEE TABLE 1

### TEST INSTRUMENTS

L : HP 4285A PRECISION LCR METER (or equivalent)

RDC : CHROMA MODEL 16502 MILLIOHMMETER (or equivalent)

## (3) CHARACTERISTICS

- (3)-1 Ambient temperature ..... +60°C Max.
- (3)-2 Operate temperature range ..... -40°C ~ +125°C  
(Including self temp. rise)
- (3)-3 Storage temperature range ..... -40°C ~ +125°C



MAG.LAYERS

**TABLE 1**

MAGLAYERS PT/NO.	Inductance L( $\mu$ H)	Percent Tolerance	L Test Frequency	Resistance RDC( $\Omega$ )Max.	IDC (mA) Max.
MSCH-2015C-1R0□	1.0	M	1MHz/0.25V	0.26	650
MSCH-2015C-1R5□	1.5	M	1MHz/0.25V	0.35	600
MSCH-2015C-2R2□	2.2	M	1MHz/0.25V	0.52	500
MSCH-2015C-3R3□	3.3	M	1MHz/0.25V	0.65	480
MSCH-2015C-4R7□	4.7	M	1MHz/0.25V	0.78	300
MSCH-2015C-5R6□	5.6	M	1MHz/0.25V	0.84	280
MSCH-2015C-6R8□	6.8	M	1MHz/0.25V	1.30	250
MSCH-2015C-8R6□	8.6	M	1MHz/0.25V	1.52	230
MSCH-2015C-100□	10	K,M	1MHz/0.25V	1.62	200
MSCH-2015C-150□	15	K,M	1MHz/0.25V	2.01	150
MSCH-2015C-220□	22	K,M	1MHz/0.25V	3.77	100

※ □ specify the inductance tolerance, K( $\pm$ 10%), M( $\pm$ 20%)

※ IDC : Based on inductance change ( $\Delta$ L/Lo :  $\leq$  drop 10%) @ ambient temp. 25°C

**(4) RELIABILITY TEST METHOD  
MECHANICAL**

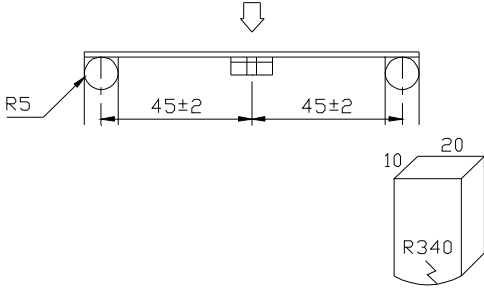
TEST ITEM	SPECIFICATION	TEST DETAILS
Substrate bending	$\Delta L/L_0 \leq \pm 5\%$  There shall be no mechanical damage or electrical damage.	The sample shall be soldered onto the printed circuit board in figure 1 and a load applied until the figure in the arrow direction is made approximately 3mm.(keep time 30 seconds) PCB dimension shall the page 7/9 F(Pressurization)  PRESSURE ROD figure-1
Vibration	$\Delta L/L_0 \leq \pm 5\%$  There shall be no mechanical damage.	The sample shall be soldered onto the printed circuit board and when a vibration having an amplitude of 1.52mm and a frequency of from 10 to 55Hz/1 minute repeated should be applied to the 3 directions (X,Y,Z) for 2 hours each. (A total of 6 hours)
Solderability	New solder More than 90%	Flux (rosin, isopropyl alcohol{JIS-K-1522}) shall be coated over the whole of the sample before hard, the sample shall then be preheated for about 2 minutes in a temperature of 130~150°C and after it has been immersed to a depth 0.5mm below for 3±0.2 seconds fully in molten solder M705 with a temperature of 245±5°C.  More than 90% of the electrode sections shall be covered with new solder smoothly when the sample is taken out of the solder bath.

## MECHANICAL

TEST ITEM	SPECIFICATION	
Resistance to Soldering heat (reflow soldering)	There shall be no damage or problems.	<p style="text-align: center;"><b>Temperature profile of reflow soldering</b></p> <p>The specimen shall be passed through the reflow oven with the condition shown in the above profile for 1 time.</p> <p>The specimen shall be stored at standard atmospheric conditions for 1 hour, after which the measurement shall be made.</p>

## ELECTRICAL

TEST ITEM	SPECIFICATION	TEST DETAILS
Insulation resistance	There shall be no other damage or problems.	DC 100V voltage shall be applied across this sample of top surface and the terminal. The insulation resistance shall be more than $1 \times 10^8 \Omega$ .
Dielectric withstand voltage	There shall be no other damage or problems.	AC 100V voltage shall be applied for 1 minute across the top surface and the terminal of this sample
Temperature characteristics	$\Delta L/L20^\circ\text{C} \leq \pm 10\%$ $0 \sim 2000 \text{ ppm}/^\circ\text{C}$	The test shall be performed after the sample has stabilized in an ambient temperature of $-20$ to $+85^\circ\text{C}$ , and the value calculated based on the value applicable in a normal temperature and normal humidity shall be $\Delta L/L20^\circ\text{C} \leq \pm 10\%$ .



## ENVIROMENT CHARACTERISTICS

TEST ITEM	SPECIFICATION																
High temperature storage	$\Delta L/Lo \leq \pm 5\%$  There shall be no mechanical damage.	The sample shall be left for $96 \pm 4$ hours in an atmosphere with a temperature of $85 \pm 2^\circ\text{C}$ and a normal humidity.  Upon completion of the measurement shall be made after the sample has been left in a normal temperature and normal humidity for 1 hour.															
Low temperature storage	$\Delta L/Lo \leq \pm 5\%$  There shall be no mechanical damage.	The sample shall be left for $96 \pm 4$ hours in an atmosphere with a temperature of $-25 \pm 3^\circ\text{C}$ .  Upon completion of the test, the measurement shall be made after the sample has been left in a normal temperature and normal humidity for 1 hour.															
Change of temperature	$\Delta L/Lo \leq \pm 5\%$  There shall be no other damage of problems	The sample shall be subject to 5 continuous cycles, such as shown in the table 2 below and then it shall be subjected to standard atmospheric conditions for 1 hour, after which measurement shall be made.  <div style="text-align: center;">                         table 2  <table border="1" style="margin-left: auto; margin-right: auto;"> <thead> <tr> <th></th> <th style="text-align: center;">Temperature</th> <th style="text-align: center;">Duration</th> </tr> </thead> <tbody> <tr> <td style="text-align: center;">1</td> <td style="text-align: center;"><math>-25 \pm 3^\circ\text{C}</math> (Thermostat No.1)</td> <td style="text-align: center;">30 min.</td> </tr> <tr> <td style="text-align: center;">2</td> <td style="text-align: center;">Standard atmospheric</td> <td style="text-align: center;">No.1→No.2</td> </tr> <tr> <td style="text-align: center;">3</td> <td style="text-align: center;"><math>85 \pm 2^\circ\text{C}</math> (Thermostat No.2)</td> <td style="text-align: center;">30 min.</td> </tr> <tr> <td style="text-align: center;">4</td> <td style="text-align: center;">Standard atmospheric</td> <td style="text-align: center;">No.2→No.1</td> </tr> </tbody> </table> </div>		Temperature	Duration	1	$-25 \pm 3^\circ\text{C}$ (Thermostat No.1)	30 min.	2	Standard atmospheric	No.1→No.2	3	$85 \pm 2^\circ\text{C}$ (Thermostat No.2)	30 min.	4	Standard atmospheric	No.2→No.1
	Temperature	Duration															
1	$-25 \pm 3^\circ\text{C}$ (Thermostat No.1)	30 min.															
2	Standard atmospheric	No.1→No.2															
3	$85 \pm 2^\circ\text{C}$ (Thermostat No.2)	30 min.															
4	Standard atmospheric	No.2→No.1															
Moisture storage	$\Delta L/Lo \leq \pm 5\%$  There shall be no mechanical damage.	The sample shall be left for $96 \pm 4$ hours in a temperature of $40 \pm 2^\circ\text{C}$ and a humidity(RH) of 90~95%.  Upon completion of the test, the measurement shall be made after the sample has been left in a normal temperature and normal humidity more than 1 hour.															
Test conditions :  The sample shall be reflow soldered onto the printed circuit board in every test.																	



## (5) LAND DIMENSION (Ref.)

PCB: GLASS EPOXY t=1.6mm

### (5)-1 LAND PATTERN DIMENSIONS

(STANDARD PATTERN) unit : mm

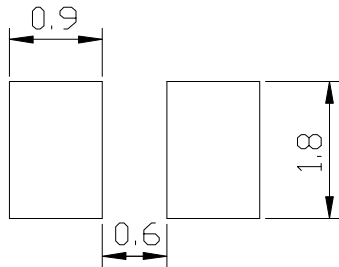

### (5)-2 SUBSTRATE BENDING TEST BENDING TEST BOARD

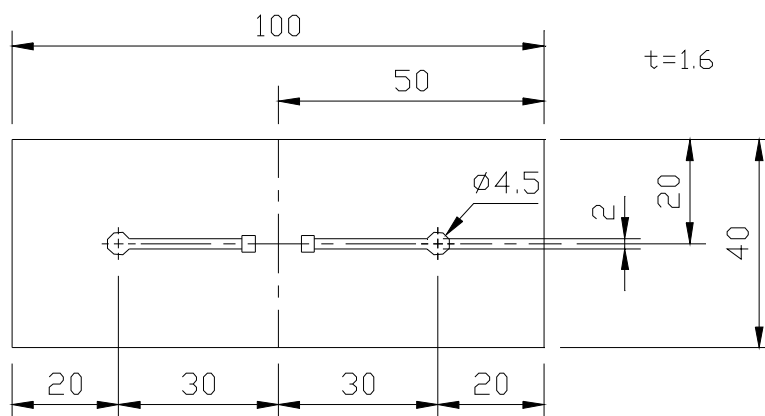

## (6) PACKAGING

### (6)-1 CARRIER TAPE DIMENSIONS (mm)

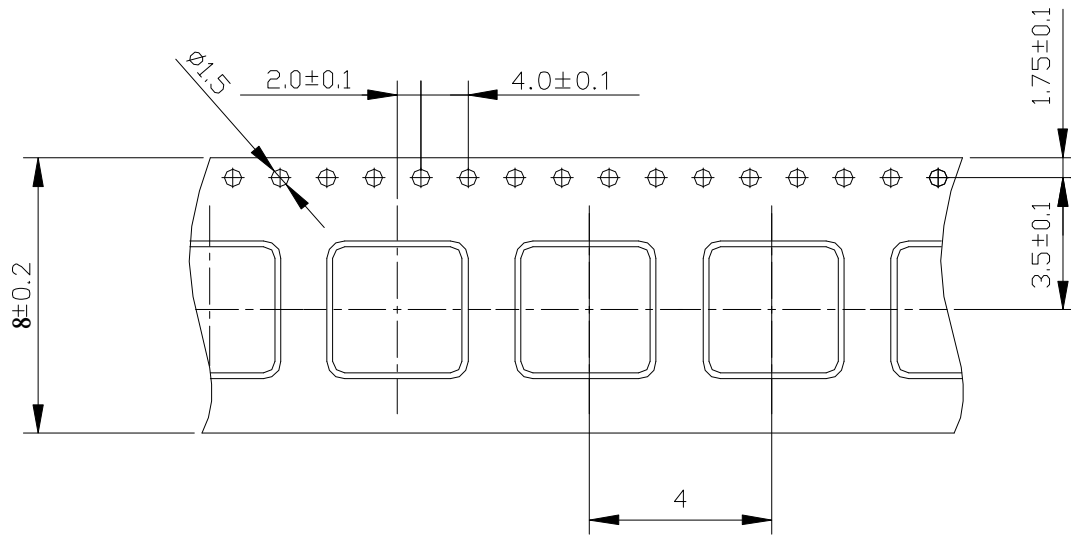

### (6)-2 TAPING DIMENSIONS (mm)

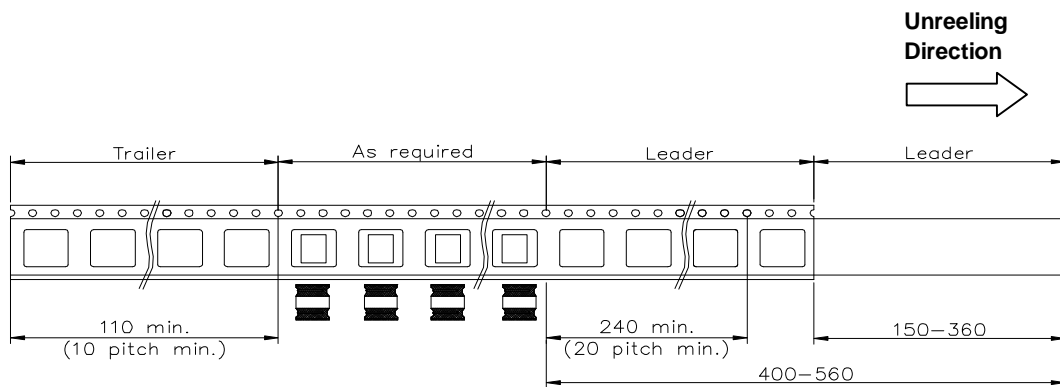

### (6)-3 REEL DIMENSIONS (mm)

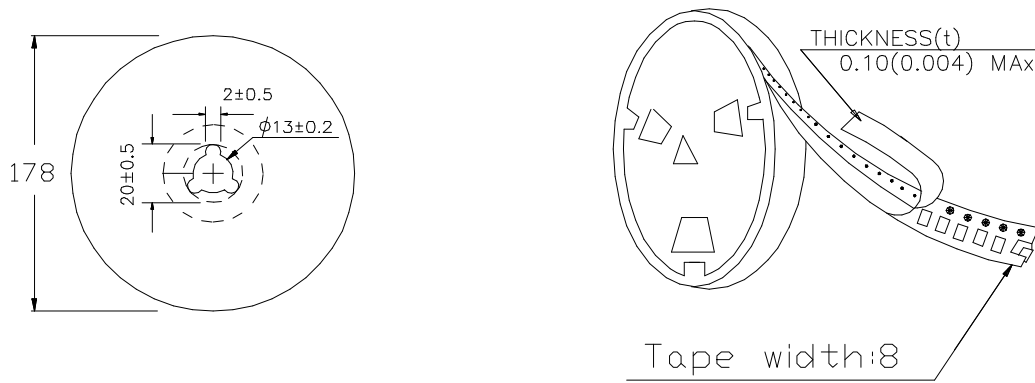

### (6)-4 QUANTITY

2500pcs/Reel

The products are packaged so that no damage will be sustained.