

SCOPE :

This specification applies to the Pb Free high current type SMD inductors for
MSCDRI-3015X-SERIES

Warn:It is here not to use synchronous rectification circuit !

PRODUCT IDENTIFICATION

MSCDRI - 3015X - 2R2 M

① ② ③ ④

- ① Product Code
- ② Dimensions Code
- ③ Inductance Code
- ④ Tolerance Code

(1) SHAPES AND DIMENSIONS

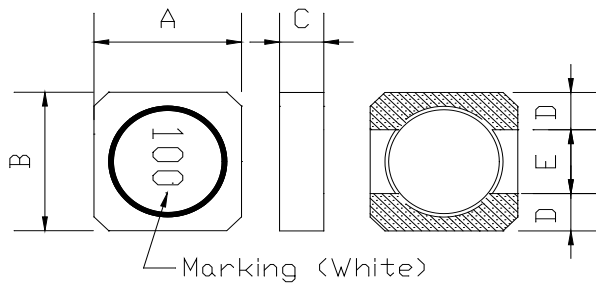

| | |
|-------------|----|
| A: 3.00±0.2 | mm |
| B: 3.00±0.2 | mm |
| C: 1.5 Max. | mm |
| D: 0.9 Typ. | mm |
| E: 1.2 Typ. | mm |

Void Appearance Tolerance Limit

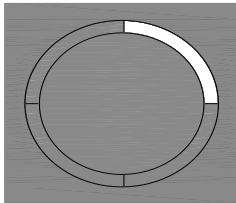

- 1.The length of the hole in the epoxy of the sealed glue position should be less than 1/4 of the DR core 's circumference, otherwise, it is NG.
- 2.The total length of the amount of hole in the epoxy should be less than 1/4 of the DR core 's circumference, otherwise, it is NG.

(2) ELECTRICAL SPECIFICATIONS

SEE TABLE 1

TEST INSTRUMENTS

- L : HP 4284A PRECISION LCR METER (or equivalent)
- RDC : CHROMA MODEL 16502 MILLIOHM METER (or equivalent)



MAG.LAYERS

TABLE 1

| MAGLAYERS PT/NO. | Inductance L(μ H) | Percent Tolerance | Test Frequency | Resistance RDC(Ω)Max. | Rated DC Current | | Marking |
|---------------------|---------------------------|----------------------|-------------------|-----------------------------------|------------------|---------|---------|
| | | | | | IDC1(A) | IDC2(A) | |
| MSCDRI-3015X-1R0□ | 1.0 | M,N | 100kHz/0.1V | 75m | 2.00 | 2.00 | 1R0 |
| MSCDRI-3015X-1R5□ | 1.5 | M,N | 100kHz/0.1V | 0.10 | 1.80 | 1.70 | 1R5 |
| MSCDRI-3015X-1R8□ | 1.8 | M,N | 100kHz/0.1V | 0.10 | 1.50 | 1.40 | 1R8 |
| MSCDRI-3015X-2R1□ | 2.1 | M,N | 100kHz/0.1V | 0.11 | 1.50 | 1.40 | 2R1 |
| MSCDRI-3015X-2R2□ | 2.2 | M,N | 100kHz/0.1V | 0.11 | 1.50 | 1.40 | 2R2 |
| MSCDRI-3015X-3R3□ | 3.3 | M,N | 100kHz/0.1V | 0.13 | 1.30 | 1.40 | 3R3 |
| MSCDRI-3015X-4R7□ | 4.7 | M,N | 100kHz/0.1V | 0.20 | 1.10 | 1.20 | 4R7 |
| MSCDRI-3015X-6R8□ | 6.8 | M,N | 100kHz/0.1V | 0.30 | 0.91 | 0.90 | 6R8 |
| MSCDRI-3015X-100□ | 10 | M,N | 100kHz/0.1V | 0.44 | 0.65 | 0.75 | 100 |
| MSCDRI-3015X-150□ | 15 | M,N | 100kHz/0.1V | 0.70 | 0.55 | 0.59 | 150 |
| MSCDRI-3015X-180□ | 18 | M,N | 100kHz/0.1V | 0.75 | 0.53 | 0.58 | 180 |
| MSCDRI-3015X-220□ | 22 | M,N | 100kHz/0.1V | 0.825 | 0.49 | 0.57 | 220 |
| MSCDRI-3015X-330□ | 33 | M,N | 100kHz/0.1V | 1.30 | 0.42 | 0.48 | 330 |
| MSCDRI-3015X-470□ | 47 | M,N | 100kHz/0.1V | 1.55 | 0.32 | 0.40 | 470 |
| MSCDRI-3015X-680□ | 68 | M,N | 100kHz/0.1V | 2.25 | 0.28 | 0.33 | 680 |
| MSCDRI-3015X-101□ | 100 | M,N | 100kHz/0.1V | 3.40 | 0.23 | 0.26 | 101 |

※ □ specify the inductance tolerance, M(\pm 20%), N(\pm 30%)

※ IDC1 : Based on inductance change (Δ L/Lo : drop 30% Max.) @ ambient temp. 25°C

IDC2 : Based on temperature rise (Δ T : 40°C TYP.)

Rated DC Current : The less value which is IDC1 or IDC2.

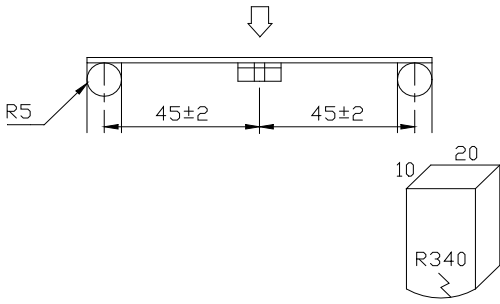

(4) RELIABILITY TEST METHOD MECHANICAL

| TEST ITEM | SPECIFICATION | TEST DETAILS |
|-------------------|--|--|
| Substrate bending | $\Delta L/L_0 \leq \pm 5\%$ There shall be no mechanical damage or electrical damage. | <p>The sample shall be soldered onto the printed circuit board in figure 1 and a load applied until the figure in the arrow direction is made approximately 3mm.(keep time 30 seconds)</p> <p>PCB dimension shall the page 7/9</p> <p>F(Pressurization)</p>  <p>10 20 R340</p> <p>PRESSURE ROD figure-1</p> |
| Vibration | $\Delta L/L_0 \leq \pm 5\%$ There shall be no mechanical damage. | <p>The sample shall be soldered onto the printed circuit board and when a vibration having an amplitude of 1.52mm and a frequency of from 10 to 55Hz/1 minute repeated should be applied to the 3 directions (X,Y,Z) for 2 hours each. (A total of 6 hours)</p> |
| Solderability | New solder More than 90% | <p>Flux (rosin, isopropyl alcohol{JIS-K-1522}) shall be coated over the whole of the sample before hard, the sample shall then be preheated for about 2 minutes in a temperature of 130~150°C and after it has been immersed to a depth 0.5mm below for 3±0.2 seconds fully in molten solder M705 with a temperature of 245±5°C.</p> <p>More than 90% of the electrode sections shall be covered with new solder smoothly when the sample is taken out of the solder bath.</p> |

MECHANICAL

| TEST ITEM | SPECIFICATION | |
|---|---------------------------------------|---|
| Resistance to Soldering heat (reflow soldering) | There shall be no damage or problems. | <p>Temperature profile of reflow soldering</p> <p>The specimen shall be passed through the reflow oven with the condition shown in the above profile for 1 time.</p> <p>The specimen shall be stored at standard atmospheric conditions for 1 hour, after which the measurement shall be made.</p> |

ELECTRICAL

| TEST ITEM | SPECIFICATION | TEST DETAILS |
|-----------------------------|--|--|
| Temperature characteristics | $\Delta L/L20^{\circ}\text{C} \leq \pm 10\%$ $0 \sim 2000 \text{ ppm}/^{\circ}\text{C}$ | The test shall be performed after the sample has stabilized in an ambient temperature of -20 to $+85^{\circ}\text{C}$, and the value calculated based on the value applicable in a normal temperature and normal humidity shall be $\Delta L/L20^{\circ}\text{C} \leq \pm 10\%$. |



ENVIROMENT CHARACTERISTICS

| TEST ITEM | SPECIFICATION | | | | | | | | | | | | | | | | |
|--|---|---|--|-------------|----------|---|--|---------|---|----------------------|-----------|---|---|---------|---|----------------------|-----------|
| High temperature storage | $\Delta L/L_0 \leq \pm 5\%$ There shall be no mechanical damage. | The sample shall be left for 96 ± 4 hours in an atmosphere with a temperature of 125°C and a normal humidity. Upon completion of the measurement shall be made after the sample has been left in a normal temperature and normal humidity for 1 hour. | | | | | | | | | | | | | | | |
| Low temperature storage | $\Delta L/L_0 \leq \pm 5\%$ There shall be no mechanical damage. | The sample shall be left for 96 ± 4 hours in an atmosphere with a temperature of $-25 \pm 3^\circ\text{C}$. Upon completion of the test, the measurement shall be made after the sample has been left in a normal temperature and normal humidity for 1 hour. | | | | | | | | | | | | | | | |
| Change of temperature | $\Delta L/L_0 \leq \pm 5\%$ There shall be no other damage of problems | The sample shall be subject to 5 continuous cycles, such as shown in the table 2 below and then it shall be subjected to standard atmospheric conditions for 1 hour, after which measurement shall be made. <div style="text-align: center;"> table 2 <table border="1" style="margin: auto;"> <thead> <tr> <th></th> <th style="text-align: center;">Temperature</th> <th style="text-align: center;">Duration</th> </tr> </thead> <tbody> <tr> <td style="text-align: center;">1</td> <td style="text-align: center;">$-25 \pm 3^\circ\text{C}$ (Thermostat No.1)</td> <td style="text-align: center;">30 min.</td> </tr> <tr> <td style="text-align: center;">2</td> <td style="text-align: center;">Standard atmospheric</td> <td style="text-align: center;">No.1→No.2</td> </tr> <tr> <td style="text-align: center;">3</td> <td style="text-align: center;">$85 \pm 2^\circ\text{C}$ (Thermostat No.2)</td> <td style="text-align: center;">30 min.</td> </tr> <tr> <td style="text-align: center;">4</td> <td style="text-align: center;">Standard atmospheric</td> <td style="text-align: center;">No.2→No.1</td> </tr> </tbody> </table> </div> | | Temperature | Duration | 1 | $-25 \pm 3^\circ\text{C}$ (Thermostat No.1) | 30 min. | 2 | Standard atmospheric | No.1→No.2 | 3 | $85 \pm 2^\circ\text{C}$ (Thermostat No.2) | 30 min. | 4 | Standard atmospheric | No.2→No.1 |
| | Temperature | Duration | | | | | | | | | | | | | | | |
| 1 | $-25 \pm 3^\circ\text{C}$ (Thermostat No.1) | 30 min. | | | | | | | | | | | | | | | |
| 2 | Standard atmospheric | No.1→No.2 | | | | | | | | | | | | | | | |
| 3 | $85 \pm 2^\circ\text{C}$ (Thermostat No.2) | 30 min. | | | | | | | | | | | | | | | |
| 4 | Standard atmospheric | No.2→No.1 | | | | | | | | | | | | | | | |
| Moisture storage | $\Delta L/L_0 \leq \pm 5\%$ There shall be no mechanical damage. | The sample shall be left for 96 ± 4 hours in a temperature of $40 \pm 2^\circ\text{C}$ and a humidity(RH) of 90~95%. Upon completion of the test, the measurement shall be made after the sample has been left in a normal temperature and normal humidity more than 1 hour. | | | | | | | | | | | | | | | |
| Test conditions : The sample shall be reflow soldered onto the printed circuit board in every test. | | | | | | | | | | | | | | | | | |

(5) LAND DIMENSION (Ref.)

PCB: GLASS EPOXY t=1.6mm

(5)-1 LAND PATTERN DIMENSIONS

(STANDARD PATTERN)

unit : mm

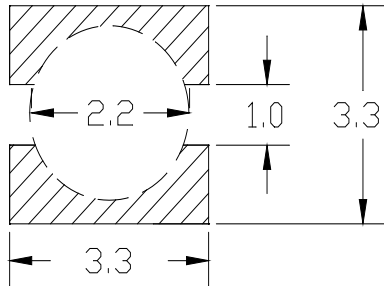

(5)-2 SUBSTRATE BENDING TEST BENDING TEST BOARD

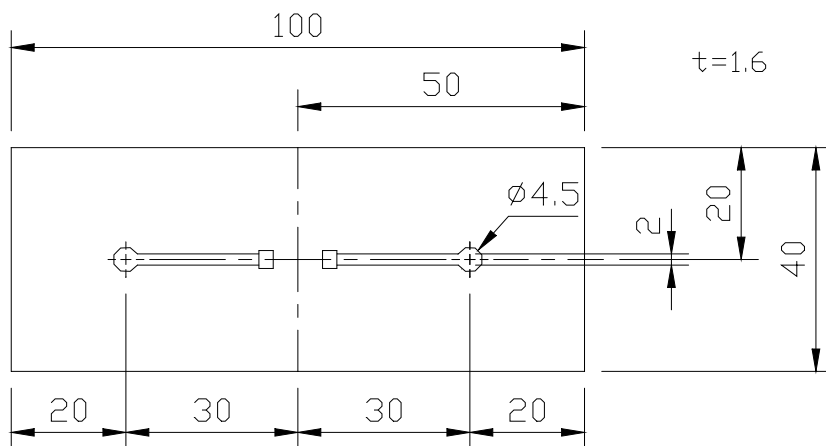

(6) PACKAGING

(6)-1 CARRIER TAPE DIMENSIONS (mm)

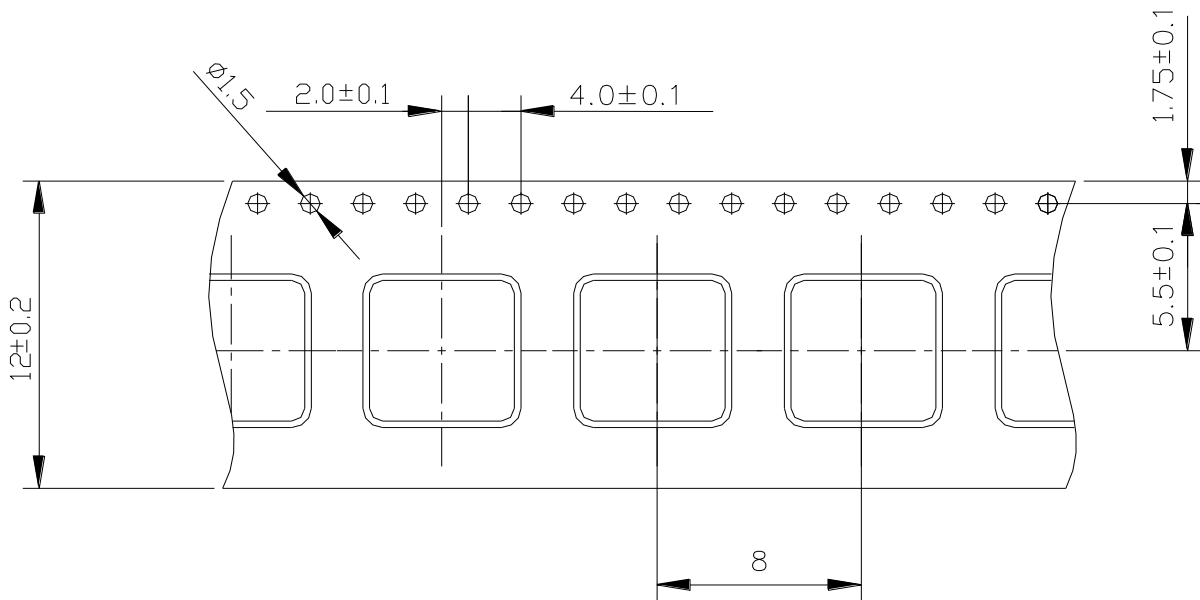

(6)-2 TAPING DIMENSIONS (mm)

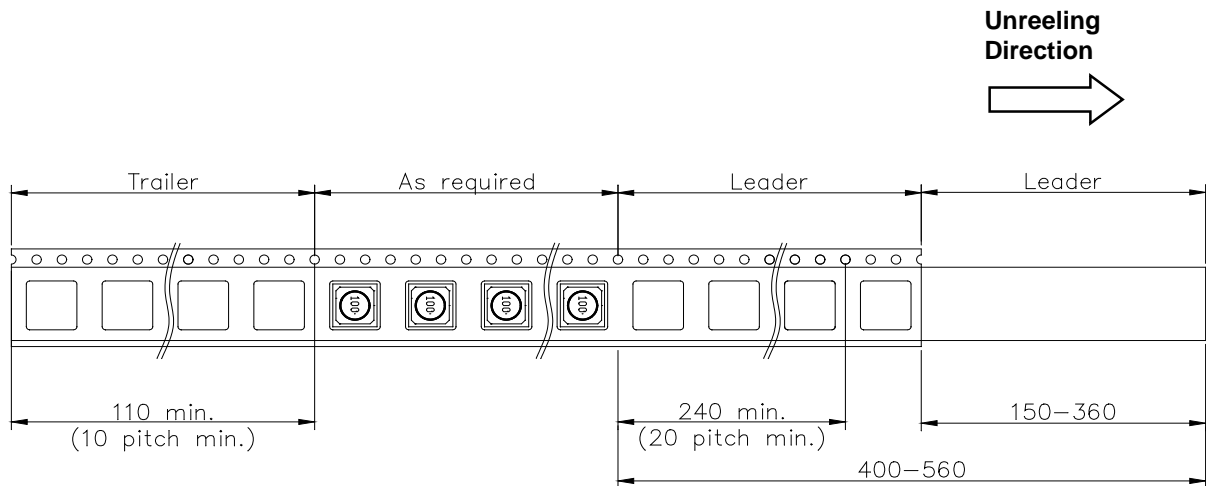

(6)-3 REEL DIMENSIONS (mm)

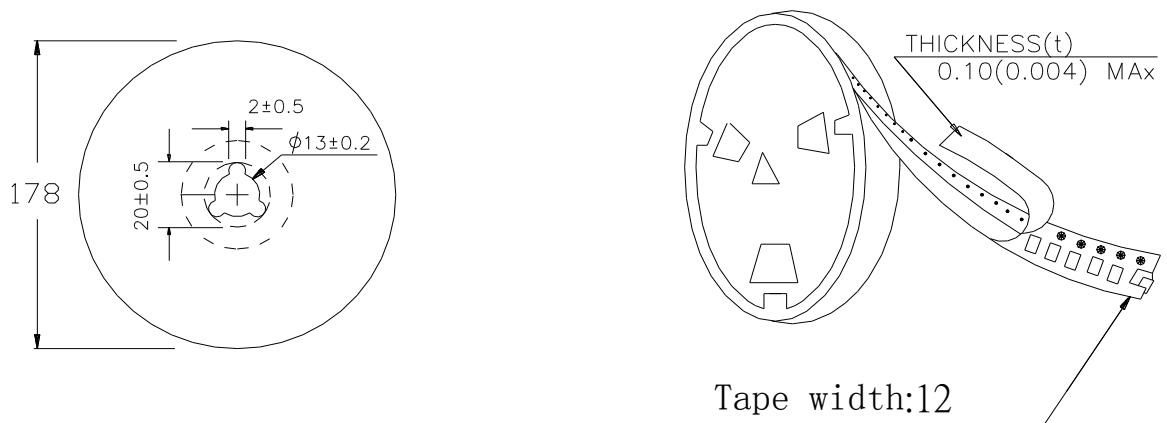

(6)-4 QUANTITY

1000pcs/Reel

The products are packaged so that no damage will be sustained.



MAG.LAYERS