

I . SCOPE :

This specification applies to the Pb Free Common mode filters
for MCU-231512-SERIES

PRODUCT IDENTIFICATION

MCU- 231512 - 900

① ② ③

- ① Product Code
- ② Dimensions Code
- ③ Impedance Code
- ④ Inner Control Code

II . INDEX :

LISTED ITEM	ATTACHEMENT & TABLES	PAGE
1. SHAPES AND DIMENSIONS	Please see (1)	2/8
2. ELECTRICAL SPECIFICATIONS	Please see (2)	2/8 , 3/8
3. CHARACTERISTICS	Please see (3)	2/8 , 3/8
4. RELIABILITY TEST METHOD	Please see (4)	4/8 , 5/8
5. RECOMMENDED SOLDERING CONDITIONS	Please see (5)	6/8
6. PACKAGING	Please see (6)	7/8 , 8/8
7. ATTENTION IN CASE OF USING	Please see (7)	8/8
8.STANDARD TEST CONDITIONS Unless otherwise specified, test condition should be Temp.= 20±5℃, Humidity= 35~85% But if needed, then test condition should be Temp.= 20±2℃, Humidity= 65±5%		
9.SHELF LIFE Storage Condition:The temperature should be within-40℃ ~105℃ and humidity should be less than 75%RH. The product should be used within 12 months from the time of delivery. In addition, suggest to use product within 6 months from the time of delivery.		



(1) SHAPES AND DIMENSIONS

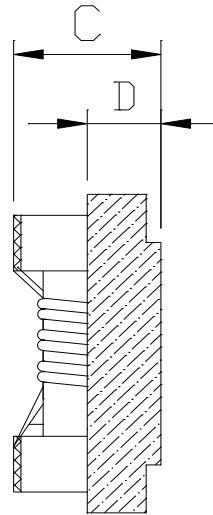
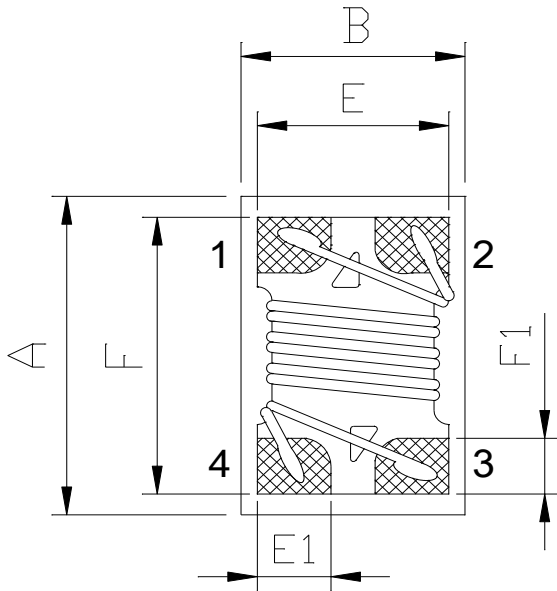

A: 2.29 Max.	mm
B: 1.52 Max.	mm
C: 1.20 Max.	mm
D: 0.50 Typ.	mm
E: 1.27 Typ.	mm
E1: 0.50 Typ.	mm
F: 2.03 Typ.	mm
F1: 0.40 Typ.	mm

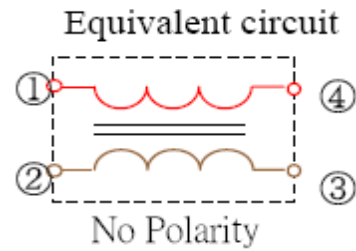

(2) ELECTRICAL SPECIFICATIONS

SEE TABLE 1

TEST INSTRUMENTS

Z : HP 4291B IMPEDANCE ANALYZER (or equivalent)

RDC : CHROMA MODEL 16502 MILLIOHMMETER (or equivalent)

I.R : CHROMA MODEL 19073 AC/DC/IR HIPOT TESTER (or equivalent)

(3) CHARACTERISTICS

(3)-1 Operate temperature range $-40^{\circ}\text{C} \sim +125^{\circ}\text{C}$

(Including self temp. rise)

(3)-2 Storage temperature range $-40^{\circ}\text{C} \sim +125^{\circ}\text{C}$



MAG.LAYERS

TABLE 1

MAGLAYERS PT/NO.	Z(Ω) Impedance @100MHz	RDC (Ω) max. (1 line)	Rated Voltage Vdc(V)	Idc Max.(mA)	Withstand Voltage (V)	Insulation Resistance (M Ω)Min.
MCU-231512-300	30 \pm 25%	0.20	50	1300	125	10
MCU-231512-420	42 \pm 25%	0.20	50	1300	125	10
MCU-231512-670	67 \pm 25%	0.25	50	1200	125	10
MCU-231512-900	90 \pm 25%	0.27	50	1000	125	10
MCU-231512-121	120 \pm 25%	0.30	50	900	125	10
MCU-231512-181	180 \pm 25%	0.40	50	700	125	10
MCU-231512-261	260 \pm 25%	0.60	50	700	125	10

* IDC : Based on temperature rise($\Delta T=20^{\circ}\text{C}$ Typ.)

TEST EQUIPMENT

1. Impedance

Measured by using HP 4291B IMPEDANCE ANALYZER

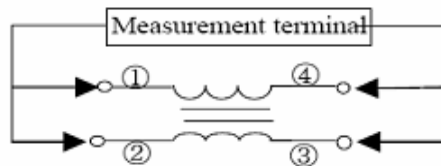

2. DC Resistance

Measured by using Chroma 16502 mill ohm meter

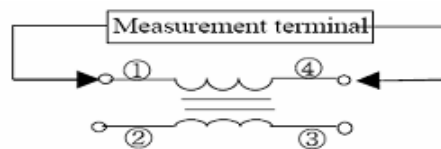

3. Insulation Resistance

Measured by using Chroma 19073

Measurement voltage: 50v, 3S

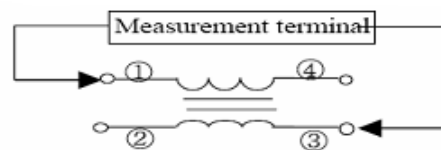

(4) RELIABILITY TEST METHOD

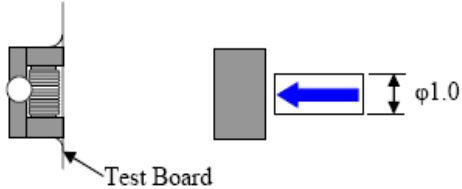
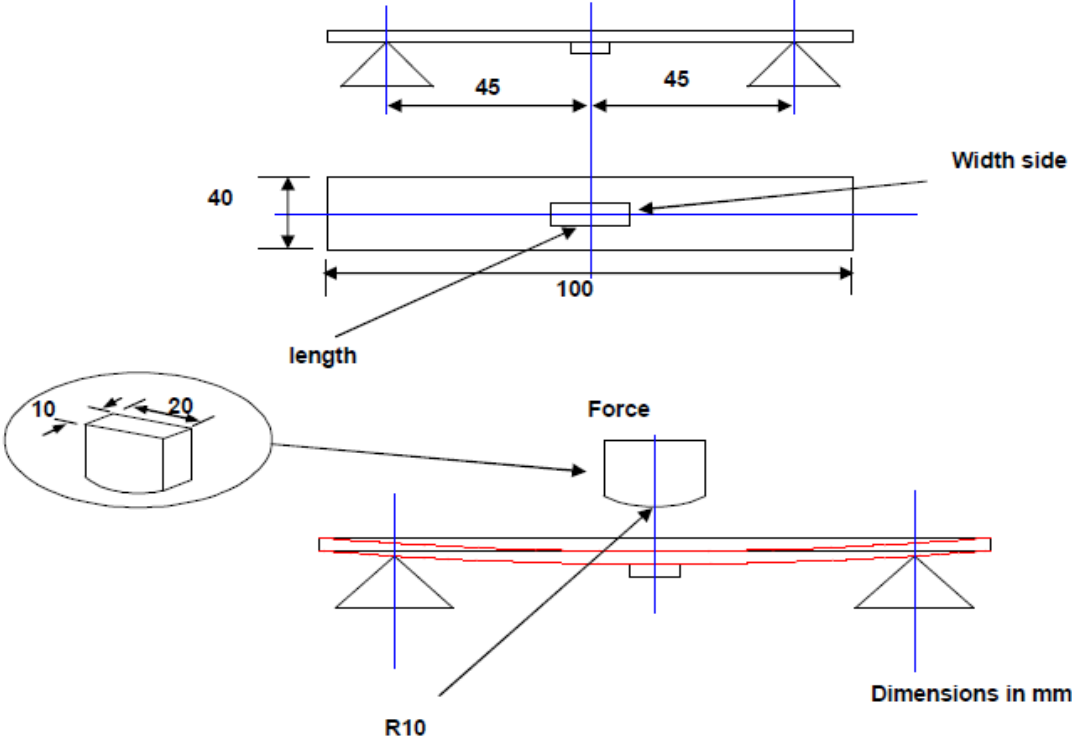
Item	Specifications	Test conditions
Solder ability	It can be connected on the Recommendation soldering condition.	Apply cream solder to the test circuit board . It is mounted on the recommendation soldering condition.
Terminal strength	The terminal electrode and the ferrite must not be damaged.	Solder a chip to test substrate , and then laterally apply a load 0.5Kg in the arrow direction. 
Strength on pc board bending	The terminal electrode and the ferrite must not be damaged.	Soldering a chip to a test substrate , bend the substrate by 2mm and then return.  <p>Test board : Glass base epoxy multiplayer board pc board pattern. PC board pattern : Recommended PC board pattern.</p>

Item	Specifications	Test conditions
High temperature	<p>Appearance : Ferrite shall not be damaged. Impedance: Within $\pm 20\%$ of the initial value. insulation resistance: $>10(M\Omega)$ DC resistance : standard value inside.</p>	Temperature : $+125\pm 2^{\circ}C$ Applied voltage : Rated voltage Applied current : Rated current Testing time : 168 ± 5 hours Measurement : After placing for 24 hours min.
Humidity resistance		Temperature : $+85\pm 2^{\circ}C$ Humidity : 90 to 95%RH Applied current : Rated current Applied voltage : Rated voltage Testing time : 500 ± 12 hours Measurement : After placing for 24 hours min.
Thermal shock		Temperature : $-40^{\circ}C, +125^{\circ}C$ kept stabilized for 30 minutes each. Cycle : 5 cycle Measurement : After placing for 24 hours min.
Low temperature Storage		Temperature : $-40\pm 2^{\circ}C$ Testing time : 168 ± 5 hours Measurement : After placing for 24 hours min.
Vibration	Appearance : Ferrite shall not be damaged.	Frequency : 10 to 50 Hz Amplitude : 1.52 mm Dimension and times : X ,Y and Z directions for 2 hours each.



(5) RECOMMENDED SOLDERING CONDITIONS

(Please use this product by reflow soldering)

(5)-1 RECOMMENDED FOOTPRINT

Unit: mm

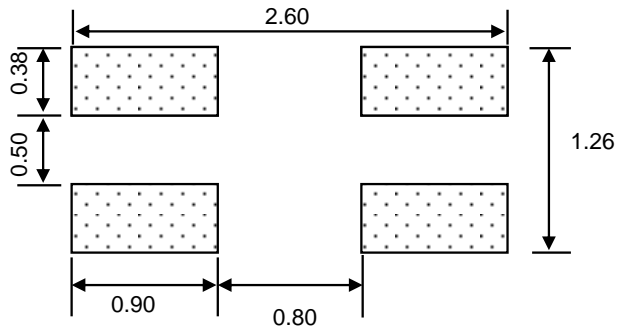

(5)-2 RECOMMENDED REFLOW PATTERN

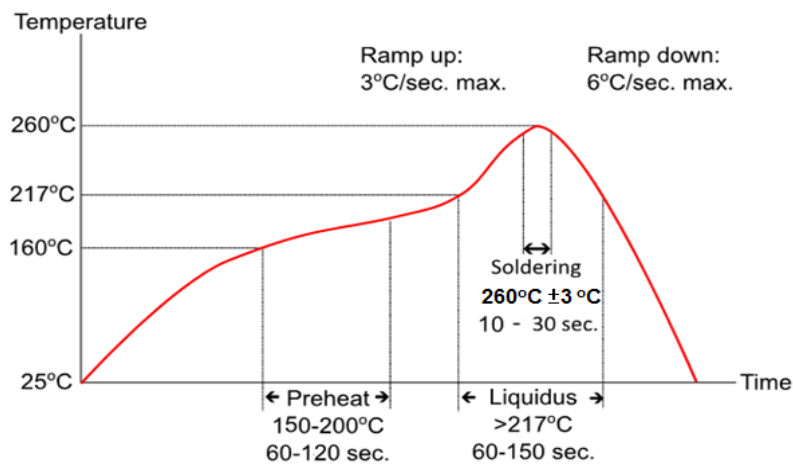

(5)-3 IRON SOLDERING

Use a solder iron of less than 30W when soldering, do not allow the soldering iron tip directly touch the Ceramic body outside of terminal electrode.

3 seconds max. at 260°C.



MAG.LAYERS

(6) PACKAGING

(6)-1 CARRIER TAPE DIMENSIONS (mm)

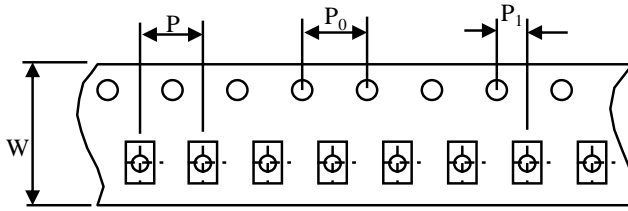

W	: 8.0	mm
P	: 4.0	mm
P_0	: 4.0	mm
P_1	: 2.0	mm

(6)-2 TAPING DIMENSIONS (mm)

There shall not continuation more than two vacancies of the product.

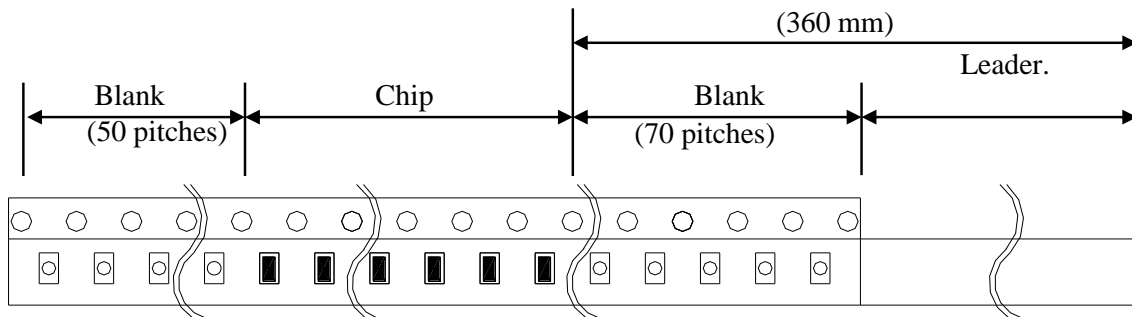

(6)-3 REEL DIMENSIONS

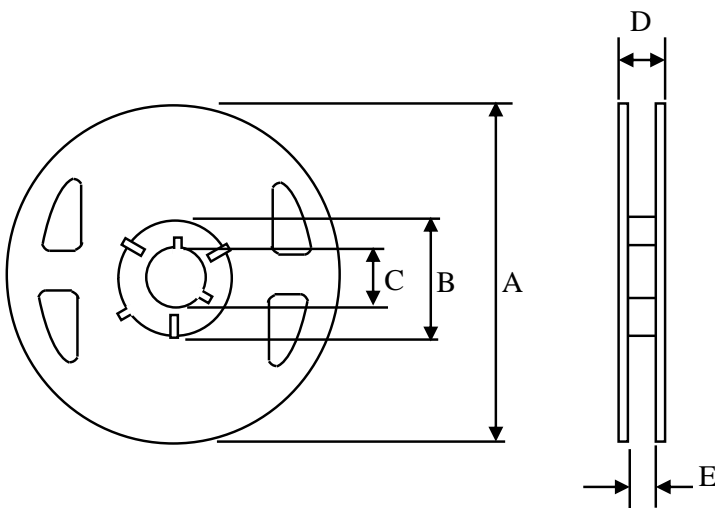

A	: 178	mm
B	: 60	mm
C	: 13	mm
D	: 12	mm
E	: 8.4	mm



MAG.LAYERS

(6)-4 COVER TAPE PEEL STRENGTH

The force for tearing off cover tape is 0.1~0.6(N) in the arrow direction at the following conditions:

Temperature : 5 ~ 35°C

Humidity : 45 ~ 85%

Atmospheric pressure : 860 ~ 1060 hpa

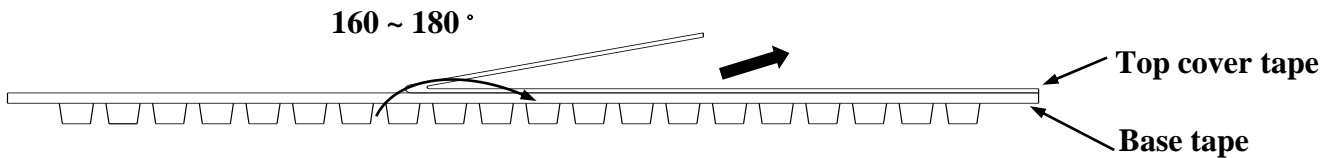

(6)-5 QUANTITY

2000 pcs/Reel

(6)-6 The products are packaged so that no damage will be sustained.

(7) ATTENTION IN CASE OF USING

In case of using product ,please avoid following matters:

Splashing water or salt water

Dew condenses

Toxic gas (Hydrogen sulfide, Sulfurous acid ,Chlorine, Ammonia)

Vibrations or shocks which exceed the specified condition

Please be careful for the stress to this product by board flexure or something after the mounting.

Please note that the contents may change without any prior notice due to reasons such as upgrading.

TYPICAL ELECTRICAL CHARACTERISTICS

