



RoHS Compliant  
Halogen Free  
REACH Compliant



- Noise  
Suppression
- Shield
- Multilayer
- Ferrite
- General  
Signal line

**■ Part Numbering**

AMPI	201610	1R0	M	PB6
Series Name	Dimensions Code (mm)	Inductance (uH)	Tolerance	Internal Code
1608DZ	1.6x0.8x0.8	R47 0.47	T ±30%	PB2
201210	2.0x1.25x1.0	1R0 1.0	M ±20%	PB6
201610	2.0x1.6x1.0			PE2
252010	2.5x2.0x1.0			

This specification applies to Multilayer Chip Inductors for Automotive Electronics based on AEC-Q200 except for Power train and Safety.



**AMPI-201610 Type**

**■ Dimensions**

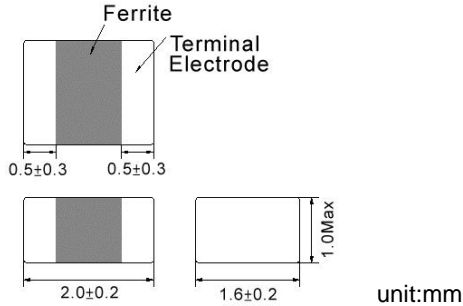

**■ Recommended Land Pattern**

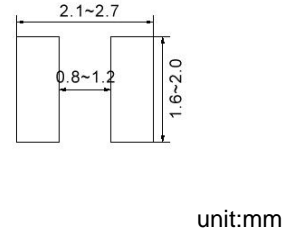

**■ Electrical Characteristics**

Part No.	Inductance	Test Freq.	RDC	Isat	Irms(mA)Max.		Tolerance
	(uH)				( $\Omega$ ) $\pm$ 25%	(mA)Max.	
AMPI-201610-R47□-PB6	0.47	3MHz,200mV	0.06	1200	1600	1200	20,30
AMPI-201610-1R0□-PB6	1.0	3MHz,200mV	0.09	850	1300	950	20,30
AMPI-201610-1R5□-PB6	1.5	3MHz,200mV	0.11	600	1200	900	20,30
AMPI-201610-2R2□-PB6	2.2	3MHz,200mV	0.11	400	1200	900	20,30
AMPI-201610-3R3□-PB6	3.3	3MHz,200mV	0.12	350	850	625	20,30
AMPI-201610-4R7□-PB6	4.7	3MHz,200mV	0.14	200	1100	800	20,30

**Note: When ordering, please specify tolerance code. Tolerance: M= $\pm$ 20% / T= $\pm$ 30%**

1. Operating temperature range - 40°C ~ 125°C
2. Isat for Inductance drop 30% from its value without current
3. Irms for When applied current to the Products, temperature rise caused by self-generated heat shall be limited to 40 °C max
4. As for the Rated current marked with \*1, Rated Current is depending on the operating temperature
5. Measure Equipment :  
L : Agilent HP4287A+16197A  
RDC : HP 4338B, or equivalent



AMPI-201610 Type

■ Characteristics Graph

Inductance vs. Frequency Characteristics

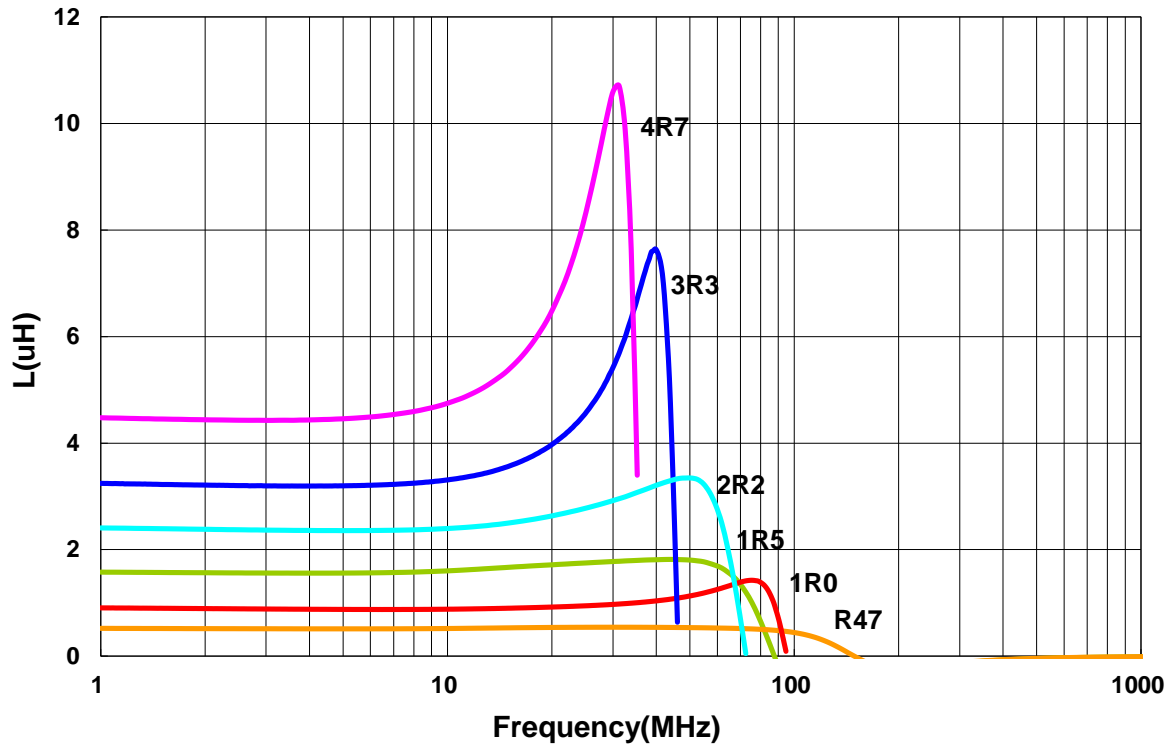

Inductance vs. DC Current

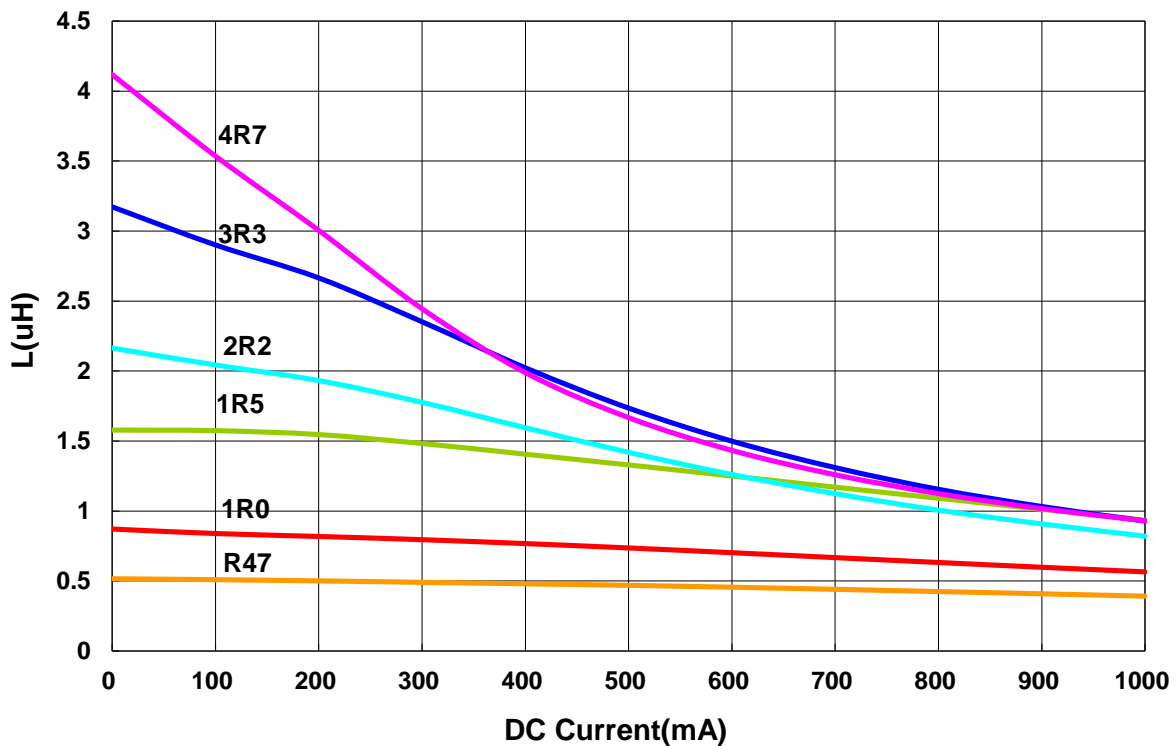

Please be sure to request approval specifications that provide further details of the products. Kindly note that the content of these specifications are subject to change or may be discontinued without prior notice. This product may not be designed/used in medical or high risk applications without Mag.Layers approval. Please contact our sales department before ordering.



**■ Packaging**

**Tape Dimensions**

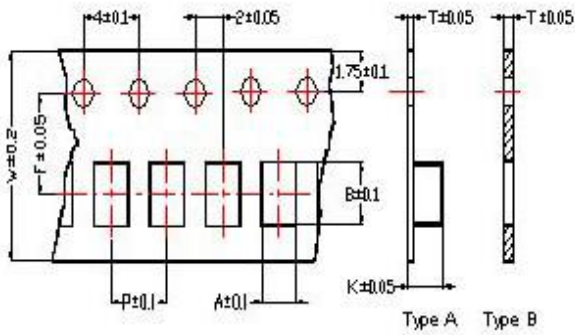

**Tape Material**

Carrier Tape: Polycarbonate (Tape A)  
Carrier Tape: Paper (Tape B)  
Cover Tape: Polystyrene

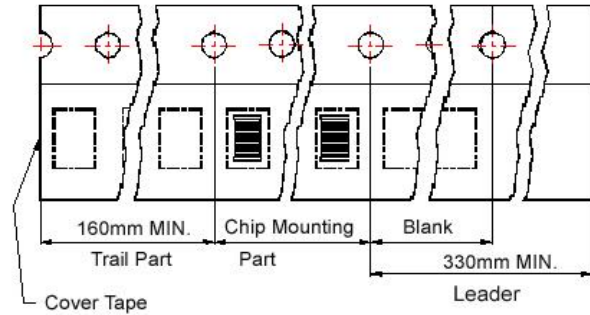

**Reel Dimensions**

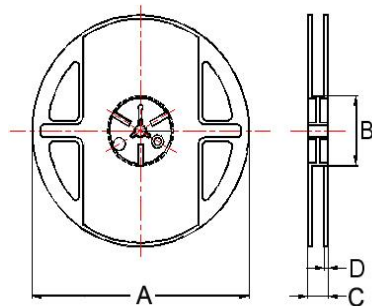

**Dimensions in mm**

TYPE	Tape Dimensions								Reel Dimensions				Quantity PCS / Reel
	A	B	T	W	P	F	K	Tape	A	B	C	D	
AMPI-1608DZ	1.05	1.85	0.95	8	4	3.5	-	B	178	60	12	1.5	4000
AMPI-201210	1.45	2.25	0.22	8	4	3.5	1.04	A	178	60	12	1.5	4000
AMPI-201610	1.8	2.2	0.22	8	4	3.5	1.15	A	178	60	12	1.5	3000
AMPI-252010	2.25	2.8	0.25	8	4	3.5	1.35	A	178	60	12	1.5	3000