



Chip Bead AMLB PY Series

**Automotive
AEC-Q200**

RoHS Compliant
Halogen Free
REACH Compliant



- Noise
Suppression
- Shield
- Multilayer
- Ferrite
- High
Current

Part Numbering

| AMLB | 100505 | 0010 | Y | PY |
|-------------|-------------------------|---|-----------|---------------|
| Series Name | Dimensions Code (mm) | Impedance (Ω) | Tolerance | Internal Code |
| | 100505 1.0x0.5x0.5 | 0010 10 0120 120 1000 1000 | Y ±25% | |

This specification applies to Multilayer Chip ferrite Bead for Automotive Electronics based on AEC-Q200 except for Power train and Safety.



AMLB-100505 Type

■ Dimensions

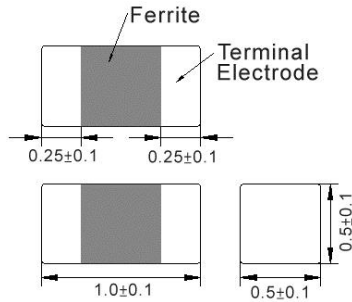

unit:mm

■ Recommended Land Pattern

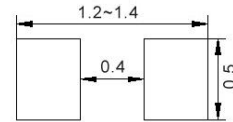

unit:mm

■ Electrical Characteristics

| Part No. | Impedance (Ω) | Test Freq. | RDC (Ω)Max. | Rated Current (mA)Max. |
|----------------------|------------------|----------------|----------------|---------------------------|
| AMLB-100505-0010Y-PY | 10 | 100 MHz,200 mV | 0.030 | 2000 |
| AMLB-100505-0030Y-PY | 30 | 100 MHz,200 mV | 0.050 | 1700 |
| AMLB-100505-0060Y-PY | 60 | 100 MHz,200 mV | 0.075 | 1500 |
| AMLB-100505-0120Y-PY | 120 | 100 MHz,200 mV | 0.090 | 1400 |
| AMLB-100505-0180Y-PY | 180 | 100 MHz,200 mV | 0.140 | 900 |
| AMLB-100505-0220Y-PY | 220 | 100 MHz,200 mV | 0.180 | 1100 |
| AMLB-100505-0600Y-PY | 600 | 100 MHz,200 mV | 0.340 | 700 |
| AMLB-100505-1000Y-PY | 1000 | 100 MHz,200 mV | 0.490 | 500 |

Note: When ordering, please specify tolerance code. Tolerance: Y=±25%

1. Operating temperature range - 40°C ~ 125°C
2. Rate Current : Applied the current to coils, the temperature rise shall not be more than 30°C
3. Measure Equipment:
Z: HP4291A
RDC: HP4338B or CHEN HWA 502



AMLB-100505 Type

Characteristics Graph

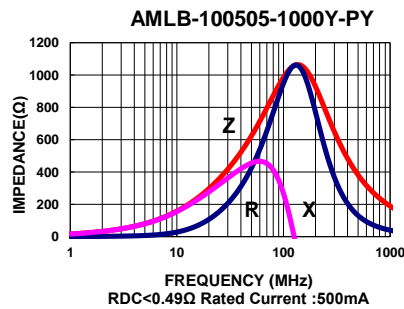
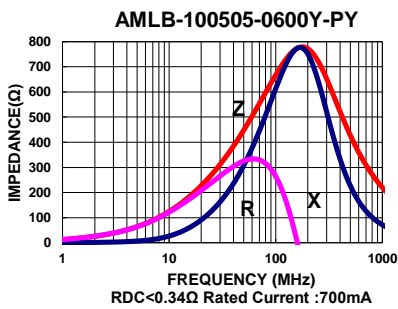
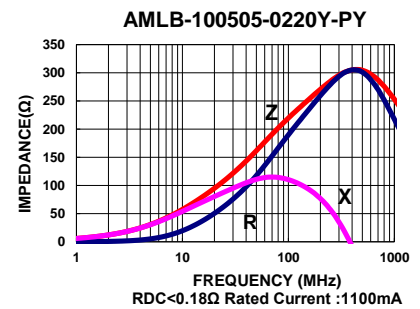
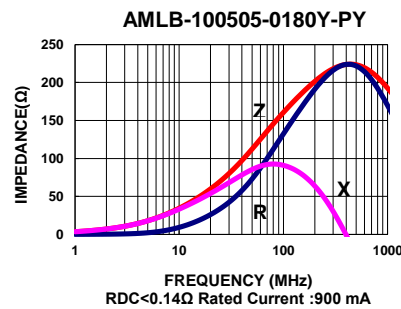
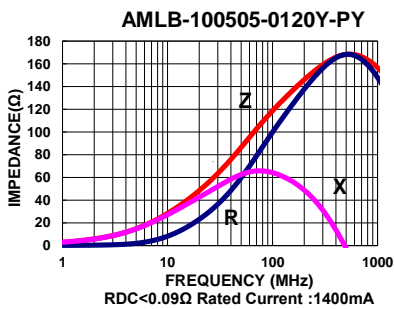
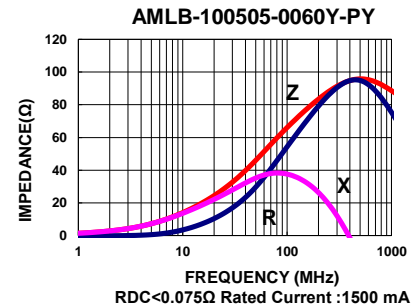
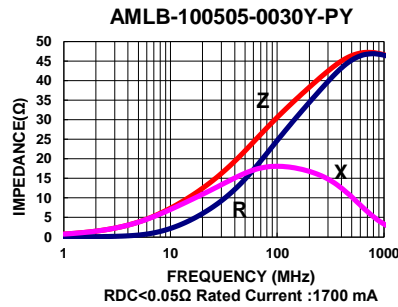
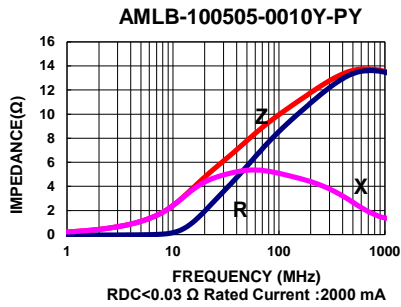



■ Packaging

Tape Dimensions

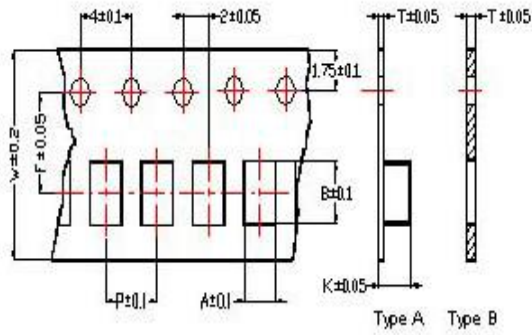

Tape Material

Carrier Tape: Polycarbonate (Tape A)
Carrier Tape: Paper (Tape B)
Cover Tape: Polystyrene

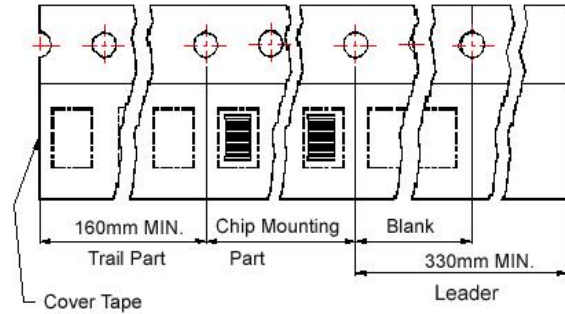

Reel Dimensions

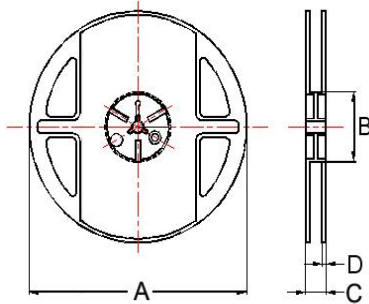

Dimensions in mm

| TYPE | Tape Dimensions | | | | | | | | Reel Dimensions | | | | Quantity |
|--------|-----------------|------|------|---|---|-----|---|------|-----------------|----|----|---|------------|
| | A | B | T | W | P | F | K | Tape | A | B | C | D | PCS / Reel |
| 100505 | 0.62 | 1.12 | 0.60 | 8 | 2 | 3.5 | - | B | 178 | 60 | 12 | 2 | 10000 |