

## ■ Application

Laptop, desktop and server applications  
High current power supplies  
Battery powered devices  
PMIC

## ■ Features

RoHS compliant & halogen free  
Low resistance and high current rating  
Magnetic core made by high performance magnetic metal powder  
AEC-Q200 grade 1 qualified

## ■ Product Identification

①      ②      ③ ④    ⑤  
MAC 1 06AH - 2R2 M - X2

- ① Product Code
- ② Dimensions
- ③ Inductance: 2R2 = 2.2 $\mu$ H
- ④ Tolerance: M =  $\pm$ 20%
- ⑤ Series Type: X2 Type

Note: Please refer to the “Product Dimension” for detail dimensions.

## ■ Electrical Performance

Part number	Inductance ±20%@0A (μH)	Rdc (mΩ)		Heat rating current (Idc) <sup>1</sup> DC amps (A)	Saturation current (Isat) <sup>2</sup> DC amps (A)
		Typ.	Max.		
MAC106AH-R10M-X2	0.1	2.0	2.5	18.0	45.0
MAC106AH-R22M-X2	0.22	4.5	5.2	14.0	29.0
MAC106AH-R33M-X2	0.33	5.2	6.8	12.0	22.0
MAC106AH-R47M-X2	0.47	7.3	8.4	11.0	18.0
MAC106AH-R68M-X2	0.68	10.8	12.7	9.0	17.0
MAC106AH-1R0M-X2	1.0	14.5	17.0	7.0	14.0
MAC106AH-1R5M-X2	1.5	20.0	26.0	6.5	12.0
MAC106AH-2R2M-X2	2.2	31.0	35.0	6.0	13.0
MAC106AH-3R3M-X2	3.3	56.0	60.0	3.5	10.0
MAC106AH-4R7M-X2	4.7	76.6	78.0	3.0	7.0
MAC106AH-6R8M-X2	6.8	101	110	2.8	3.5

**Test frequency:** 100 KHz, 0.25V.

**Test instruments:** Inductance/saturation current: Keysight 4285A or equivalent.

Rdc: ADEX AX1152D or equivalent.

### Notes:

1. The heat rating current (Idc) will cause temperature rise approximate 40°C.
2. The saturation current (Isat) will cause initial inductance drop approximate 30%.
3. All test data is referenced at 25°C ambient.
4. Operating temperature range -55°C to +125°C.
5. The part temperature (ambient + temp rise) should not exceed 125°C under the worst condition.
6. The temperature of component is affected by application conditions, e.g. circuit design, copper thickness of PCB and cooling conditions, the actual component temperature should be tested in the end application.

# Electrical Characteristics

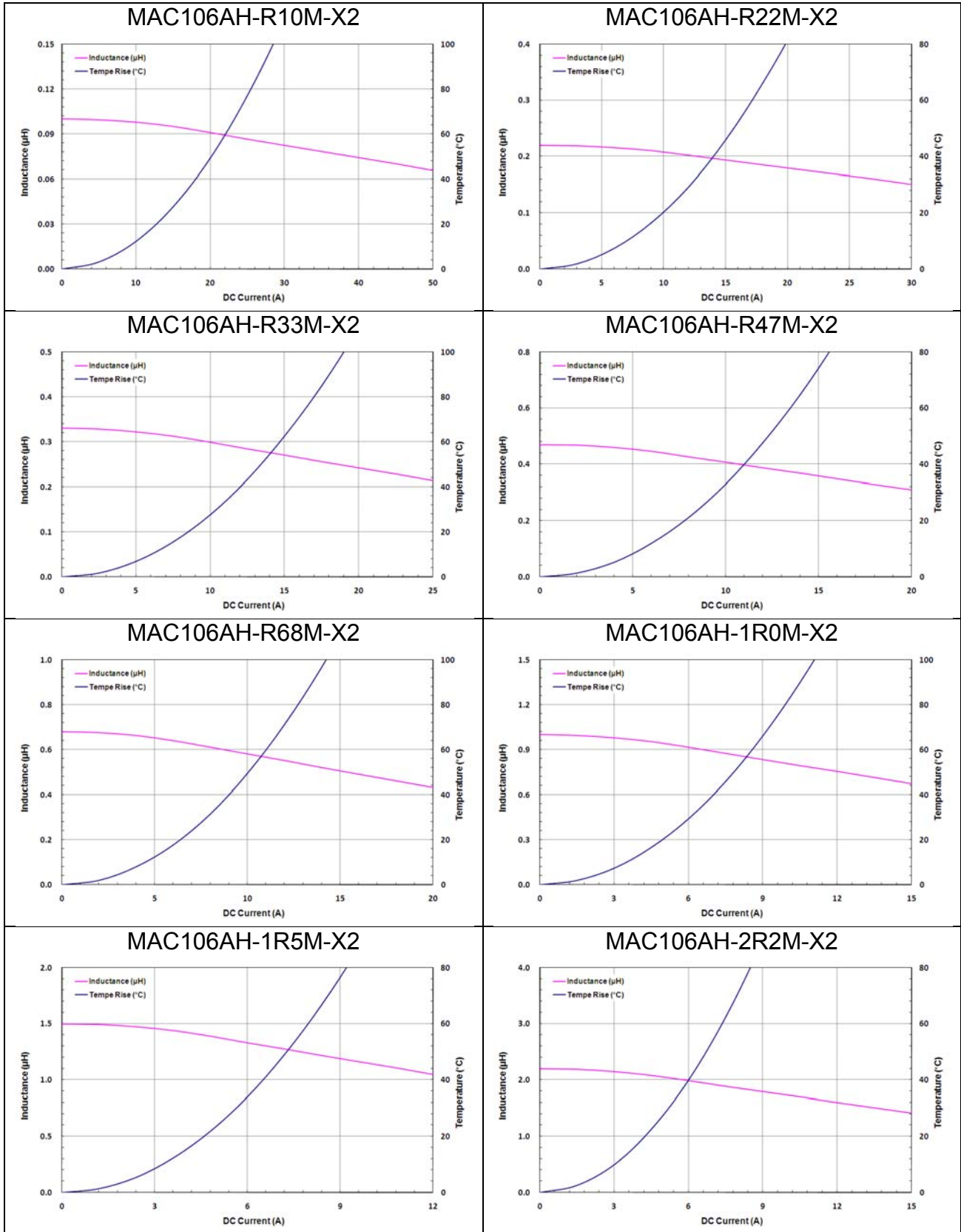

MAC106AH-3R3M-X2

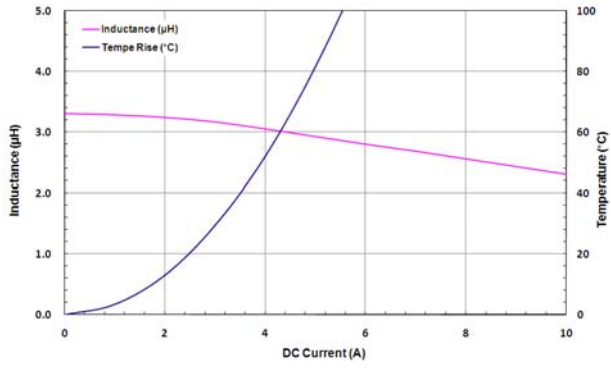

MAC106AH-4R7M-X2

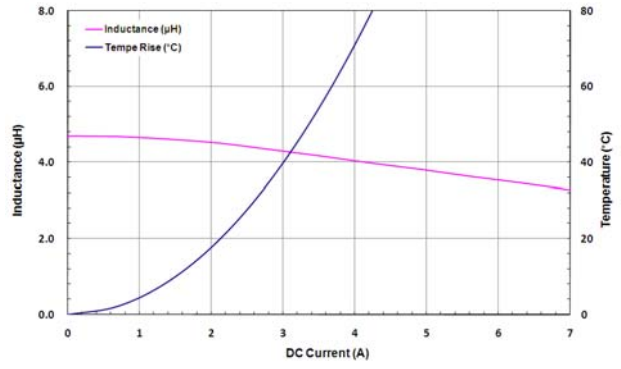

MAC106AH-6R8M-X2

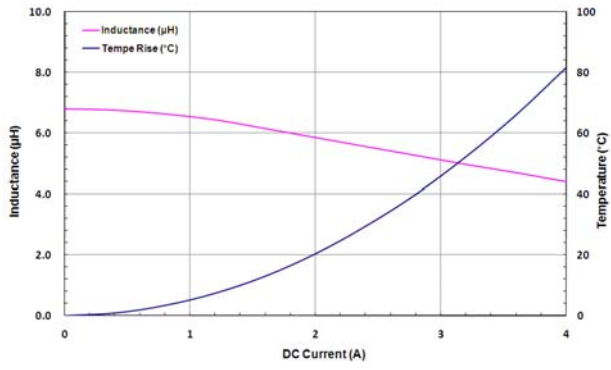

## ■ Product Dimension

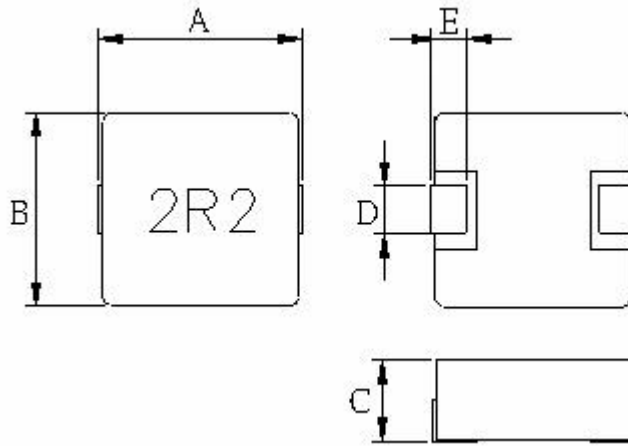

Dimension	A	B	C	D	E
Part number					
MAC106AH-SERIES-X2	7.4 Max	$6.6 \pm 0.2$	1.8 Max	$3.0 \pm 0.3$	$1.6 \pm 0.3$

Unit: mm

## ■ Recommended PCB Layout

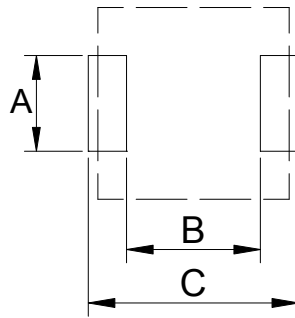

Type	06AH
A	3.5
B	3.7
C	8.4

Unit: mm

### Safety precaution

1. Do not make any through holes and copper pattern in the dotted line area. Except a copper pattern to the electrode.
2. Don't design/mount any components in contact with this product.

This power choke do not have any protective function in abnormal condition such as overload, short circuit, open conditions and etc, it shall be confirmed as the end product that there is no risk of smoking, fire, dielectric withstand voltage, insulation resistance etc. in abnormal conditions to provide protective devices and/or protection circuit in the end product. It is recommended the temperature rise of choke during operation is less than 50°C.

## ■ Packaging

### Peel-off force

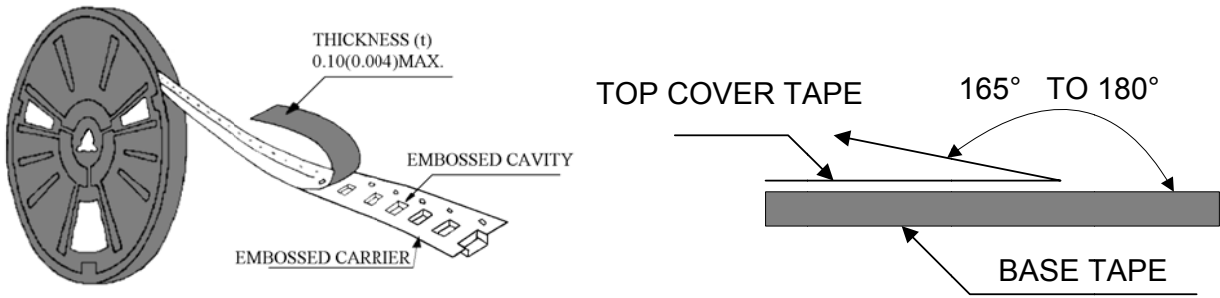

The peel off force of cover tape is 10 to 70 grams in the arrow direction.

### Dimensions

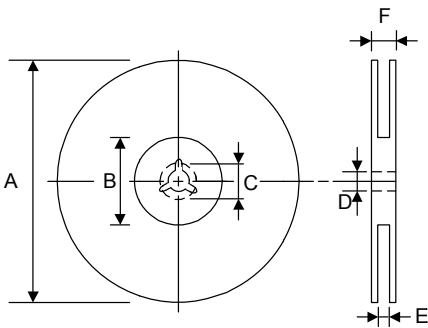

Type	A	B	C	D	E	F
330mm	330 ±2	100 ±1	21.5 ±0.5	13 ±1.0	16.4 +2.0/-0	21.4 ±2

Unit: mm

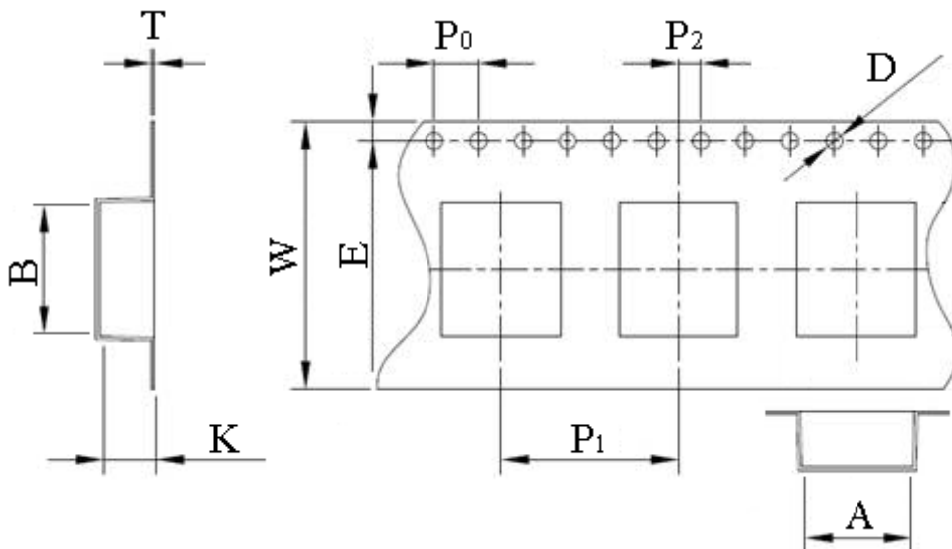

TYPE	SIZE	A	B	W	P <sub>1</sub>	K
MAC1	06AH	6.9±0.1	7.5±0.1	16.0±0.3	12.0±0.1	2.1±0.1
		P <sub>0</sub>	P <sub>2</sub>	D	E	T
		4.0±0.1	2.0±0.1	1.5±0.1	1.75±0.1	0.3±0.05

Unit: mm

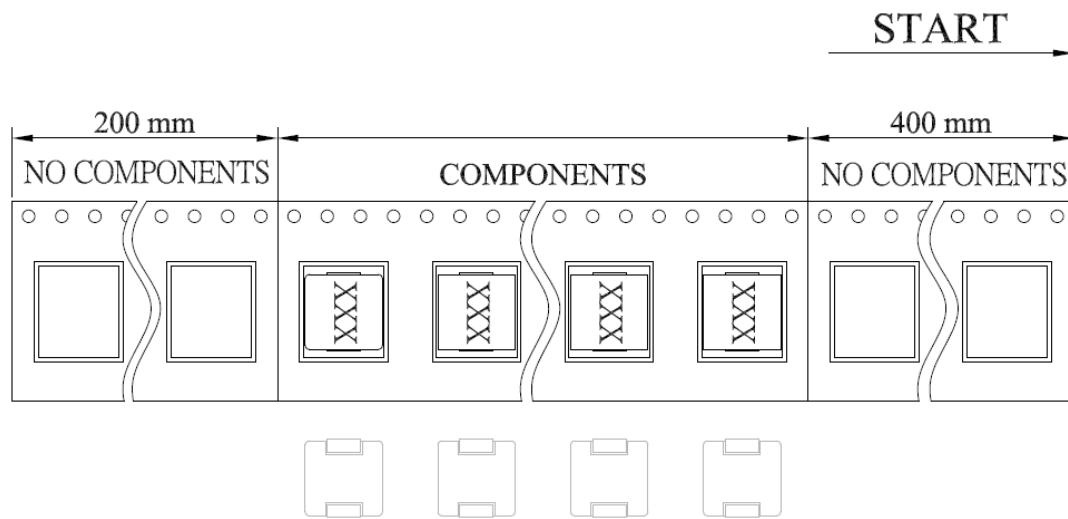

**Taping quantity**

Series	06AH
PCS/Reel	1000