



Networking Communication Components

RT Series

LAN Transformer

Part number: RT22H05

Part name :Giga Transformer Two Port

Feature

- Compliant and peak reflow temperature rating 245°C .
- Meets IEEE802.3 specification.
- Excellent common mode noise suppression.
- Packaging specification is tube.
(RT22H□□ : Tube)

Part number code

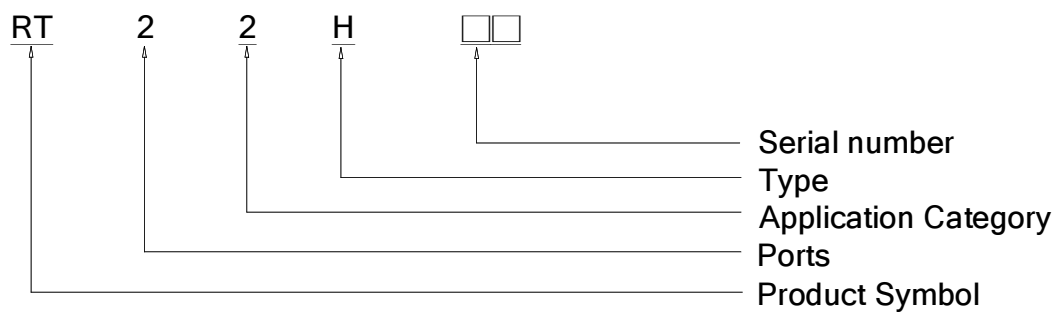

REV.	Description	Date	Drawn	Designed	Approved
A	Specification issued	09.05.2012	Yuxuan.Xuang	Yuxuan.Xiang	James.Cheng

Mechanical Dimension and Marking

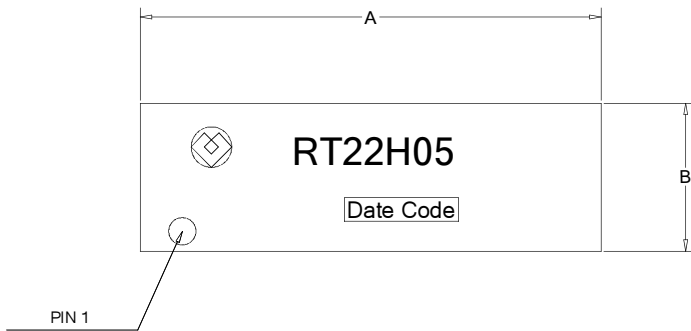

UNIT	mm	inch
A	28.10 +0.25/-0.25	1.107 +0.010/-0.010
B	11.10 +0.25/-0.25	0.437 +0.010/-0.010
C	11.00 +0.25/-0.25	0.433 +0.010/-0.010
D	3.00 +0.25/-0.25	0.118 +0.010/-0.010
E	0.30 +0.05/-0.05	0.012 +0.002/-0.002
F	1.00 +0.05/-0.05	0.039 +0.002/-0.002
G	2.00 +0.05/-0.05	0.079 +0.002/-0.002
H	23.00 +0.25/-0.25	0.906 +0.010/-0.010
I	∅0.40	∅0.016
J	5.33 +0.25/-0.25	0.210 +0.010/-0.010
K	8.89 +0.25/-0.25	0.350 +0.010/-0.010

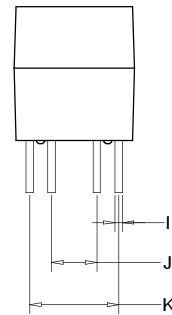
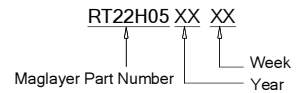
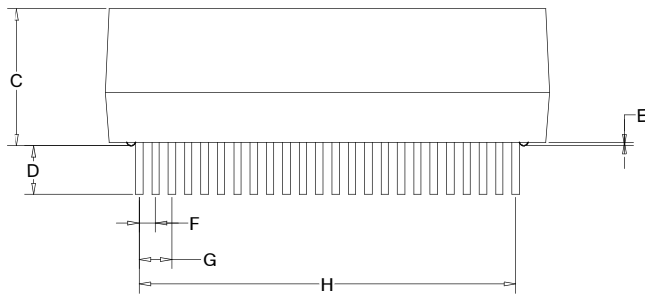

Suggested PWB Layout

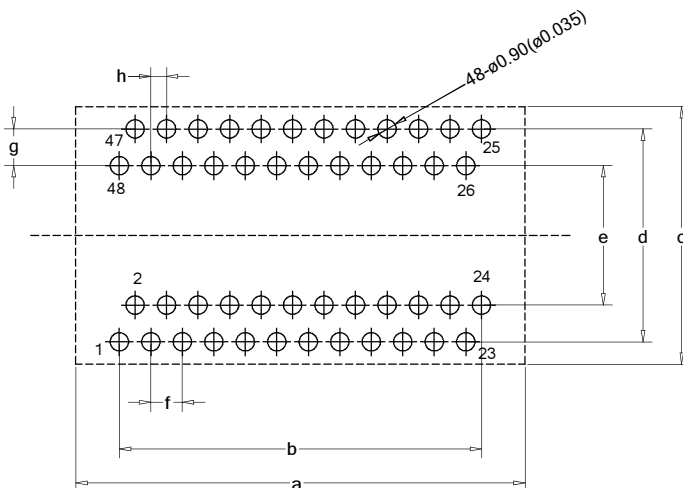

UNIT	mm	inch
a	28.10	1.107
b	23.00	0.906
c	11.10	0.437
d	8.89	0.350
e	5.33	0.210
f	2.00	0.079
g	1.78	0.070
h	1.00	0.039

Drawn	Yuxuan.Xiang	Designed	Yuxuan.Xiang	Approved	James.Cheng
-------	--------------	----------	--------------	----------	-------------

Schematics

RT22H05

CABLE SIDE

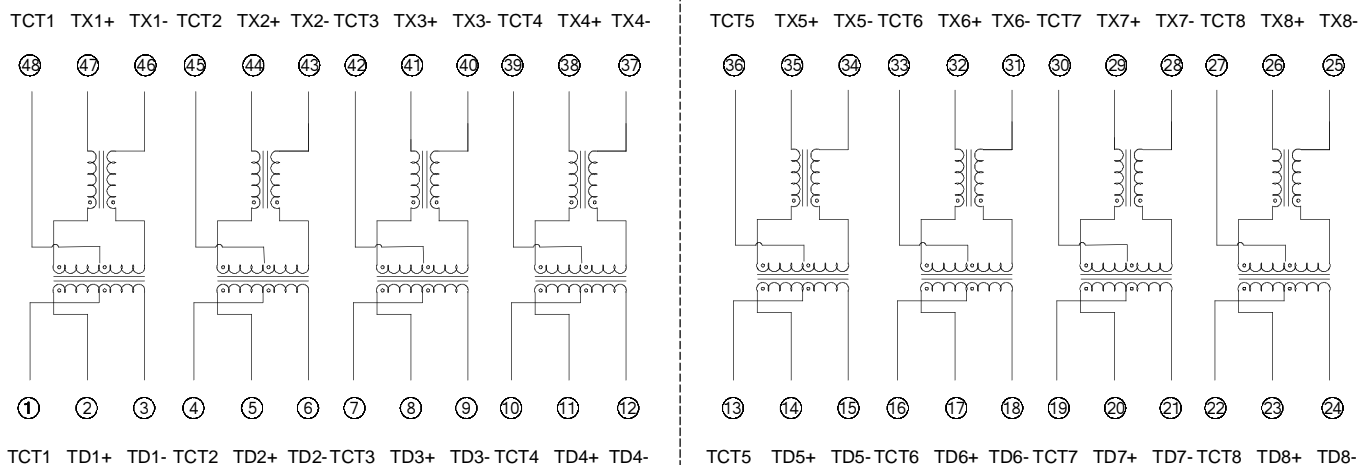

Port 1

Port 2

PHY SIDE

Electrical Specification @ 25°C, Humidity 65% RH

Inductance @ Phy side(OCL)
100KHz, 0.1V, 8mA DC Bias
350uH MIN

Part Number	Turns Ratio	Insertion Loss	Return Loss					DMCR			Crosstalk			Hipot
	100KHz	dB MAX	dB MIN					dB MIN			dB MIN			Vrms, Sec
	± 5%	1MHz-100MHz	1MHz-30MHz	40MHz-50MHz	60MHz-80MHz	100MHz	30MHz	60MHz	100MHz	30MHz	60MHz	100MHz	Pri To Sec	
RT22H05	1:1	-1.0	-18	-14.4	-13.1	-12	-10	-43	-37	-33	-40	-35	-30	1500, 60

Operating Temperature: 0°C to +70°C.
Storage Temperature: -25°C to +105°C
JSDEC Moisture: Level 1.

Wave Soldering

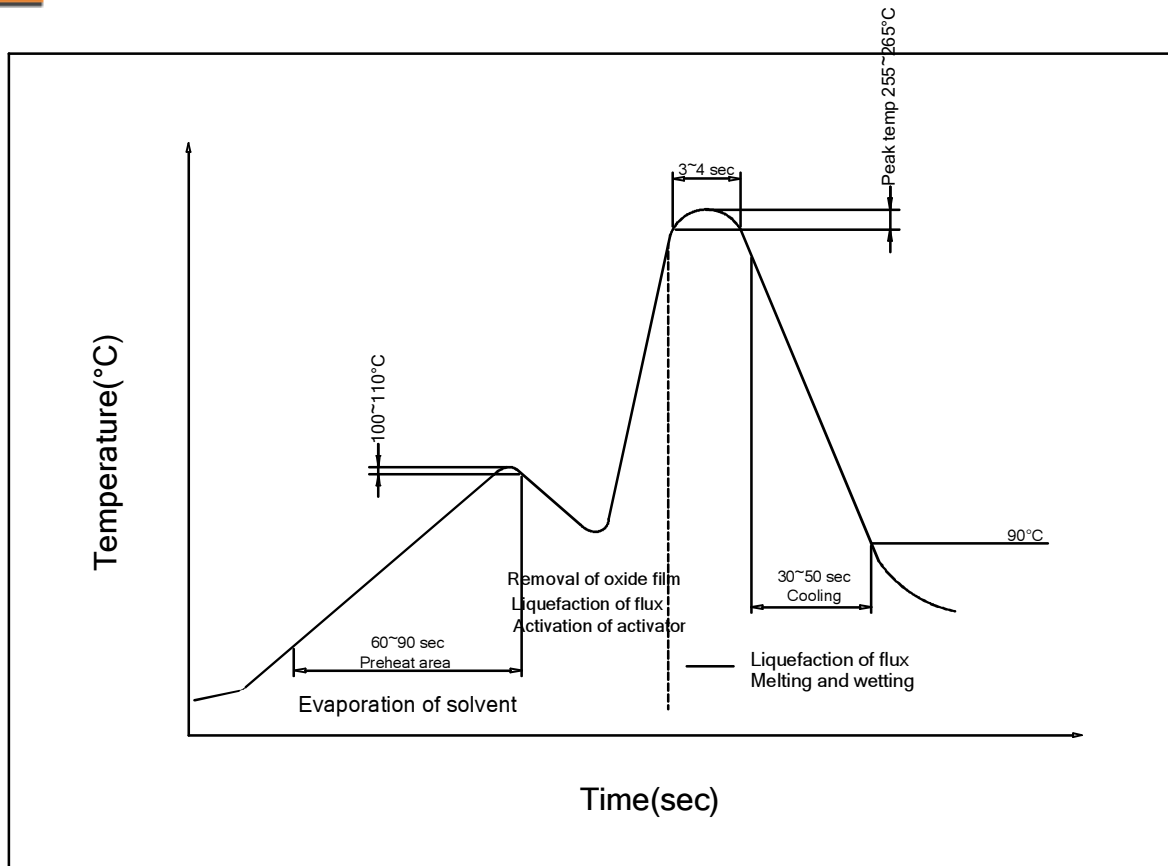

- Tip Temperature :265°C MAX.
- Tip Temperature Time: 4sec MAX.